

UniPOS

Fire Control Panel FS5100

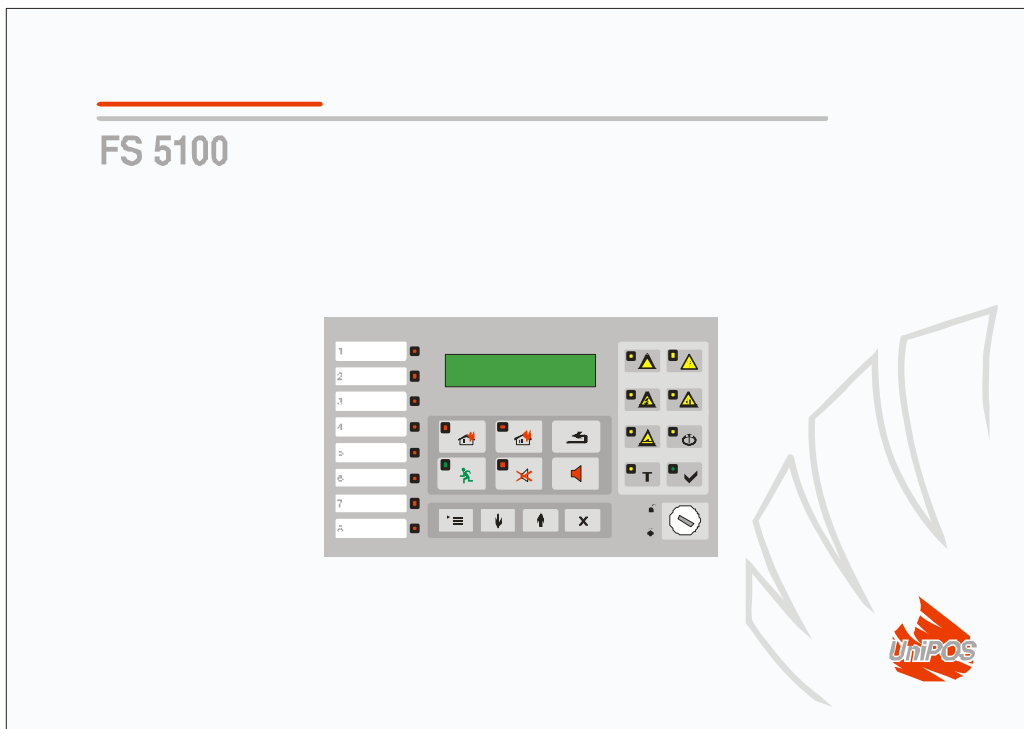

INSTRUCTION MANUAL

Contents

1. Introduction	5
2. Terminology	5
3. Function	7
4. Technical data	7
4.1. Modules	7
4.1.1. Type of modules	7
4.1.2. Features	7
4.2. Physical configuration.....	7
4.2.1. Basic configuration	7
4.2.2. Expanded configuration.....	7
4.2.3. Maximum configuration	8
4.3. Fire alarm lines	8
4.4. Controllable outputs.....	8
4.5. Common purpose relay outputs	8
4.6. Relay output for fault conditions	8
4.7. Performance	8
4.8. Indications of registered events.....	9
4.9. Power supply	9
4.9.1. Mains	9
4.9.2. Backup batteries.....	9
4.9.3. Consumption on backup batteries supply.....	9
4.9.4. Power supply to external devices	9
4.10. Dimensions.....	9
4.11. Weight	9
5. Contents of delivery	9
5.1. Fire control panel.....	9
5.2. Additional module	9
6. General information	10
6.1. Access levels.....	10
6.1.1. Access level 1.....	10
6.1.2. Access level 2.....	10
6.1.3. Access level 3.....	10
6.1.4. Access level 4.....	10
6.2. Indications and buttons for control.....	10
6.3. Function “Logical AND” of two lines	13
6.4. Conditions of the fire control panel	13
7. Duty Mode	14
7.1. Description.....	14
7.2. Indication	14
7.2.1. LED and sound indication.....	14
7.2.2. Text message	14
7.3. Using the keypad.....	14
8. Fire Condition	14
8.1. Description.....	14
8.2. Indication	14
8.2.1. LED and sound indication.....	14
8.2.2. Text messages	14
8.3. Using the keypad.....	15
9. Pre-Fire Condition	16
9.1. Description.....	16
9.2. Indication	16
9.2.1. LED and sound indication.....	16

9.2.2. Text messages	16
9.3. Using the keypad	17
10. Fault Condition	17
10.1. Description.....	17
10.2. Indication	18
10.2.1. LED and sound indication.....	18
10.2.2. Text messages	18
10.3. Using the keypad.....	19
11. Disabled Component Mode	20
11.1. Description.....	20
11.2. Indication	20
11.2.1. LED and sound indication.....	20
11.2.2. Text messages	20
11.3. Using the keypad.....	21
12. Test Mode	21
12.1. Description.....	21
12.2. Indications	21
12.2.1. LED and sound indication.....	21
12.2.2. Text messages	21
12.3. Using the keypad.....	21
13. Information and Control Mode	21
13.1. Description.....	21
13.2. Menu <i>System functions</i>	22
13.2.1. Function <i>LED and sound indicators check up</i>	23
13.2.2. Function <i>Fire alarm lines test</i>	23
13.2.3. Function <i>Disable fire alarm lines</i>	23
13.2.4. Function <i>Disable controllable outputs</i>	23
13.2.5. Menu <i>Current in fire alarm lines</i>	24
13.2.6. Menu <i>Setting the clock</i>	24
13.2.7. Menu <i>Parameter review</i>	25
13.2.8. Menu <i>Adjustment</i>	27
13.2.9. Menu <i>Archive review</i>	27
13.3. Information screen <i>Disabled Controllable Outputs</i>	28
13.4. Menu <i>Status</i>	28
13.4.1. Menu <i>Line status</i>	28
13.4.2. Menu <i>Controllable output status</i>	29
14. Set Up Mode	29
14.1. Description.....	29
14.2. Menus.....	29
14.2.1. Function <i>Password</i>	29
14.2.2. Menu <i>Line parameters</i>	30
14.2.3. Menu <i>Fire control panel parameters</i>	30
14.2.4. Function <i>Adjustment of controllable outputs</i>	30
14.2.5. Function <i>Adjustment of relay outputs</i>	31
14.2.6. Function <i>Default parameters</i>	31
14.2.7. Function <i>Clear archive</i>	31
14.2.8. Function <i>Enter new password</i>	32
15. Remote Control Mode	32
15.1. Description.....	32
15.2. Indications	32
15.2.1. LED and sound indication.....	32
15.2.2. Text messages	32
15.3. Using the keypad.....	32
16. Saving the parameters	32

17. Labour protection requirements	32
18. Installation and arrangements.....	32
18.1. To mount the fire control panel.....	32
18.2. Periphery devices assembly.....	33
18.2.1. Mounting periphery devices to controllable outputs	33
18.2.2. Mounting periphery devices to relay outputs	33
18.3. Connecting interface units.....	33
18.4. Connecting fire detectors.....	33
18.5. Connection to power supply	34
19. Fire control panel start up	34
20. How to add, remove or replace an additional module	34
21. Troubleshooting	35
22. Conditions of operation, storage and transportation	37
22.1. Operation and storage.....	37
22.1.1. Temperature	37
22.1.2. Relative humidity	37
22.2. Transportation	37
23. Warranty	37
24. Appendixes	38

1. Introduction

Fire Control Panel FS5100 is an up-to-date, high reliable, multifunctional and versatile unit, providing the user with unexpected potential in the design, installation and operation of conventional fire alarm systems.

Some of its main features and possibilities are:

- Adjustment of operating modes and parameters of each fire alarm line via built in keypad;
- User oriented menu dialogue for easy and convenient operation;
- LCD for visualization of system checkup and setup modes;
- LEDs indication for early warning of a break down or extreme conditions;
- Ability to address automatic fire detectors and manual call points in groups;
- Energy independent archive memory saving the event type, date and time, allowing for detailed analysis of the actions of the authorized personnel and possible problems in the fire protection process of the area;
- User oriented test modes allowing for a total control of the site protected;
- Built-in serial interface for connection to second level control devices, ability for connection via telephone line and standard modem;
- System expansion and functional modification (our goal is discontinuous improvement of the fire alarm equipment features), no additional cabling necessary;
- Compatible to random installation design, within the range of fire control panels resources.

All these are realizable via fire control panel's keypad and after a detailed examination of the instructions set herewith.

2. Terminology

ACCESS LEVEL – access level to various indications and control functions (see section 6.1).

ASSOCIATED OUTPUT – *controllable or relay output*, programmed by user to react (separately in Fire condition I and Fire condition II) in Fire condition via selected *fire alarm line*.

CIRCUIT BOARD CONFLICT – *fatal fault condition*, due to detected conflict between current configuration and configuration saved in the memory. Usually it occurs when an additional module has been added, removed or replaced. In such case adjust the fire control panel.

CONTROLLABLE OUTPUT – potential output that monitors the serviceability of the connection wires between the fire control panel and the executing device. Follow the special diagram for connection. (Appendix 7 c).

DISABLED CONTROLLABLE OUTPUT – *the controllable output* is switched off (executing devices can not be activated) and is not monitored for a fault condition. This feature is user defined. The indication for a disabled controllable output is common light indication and text messages on the LCD display.

DISABLED LINE – a switched off line, without power supply, not controlled for activated fire detectors and fault condition. This condition is user defined. The indication for a disabled line is common light indication and text messages on the LCD display.

FATAL FAULT CONDITION – fault condition that does not allow the fire control panel to continue operation. The indication is common light indication, local sound indication and text messages on the LCD display.

FIRE ALARM LINE (further on it will be referred as **LINE**) – automatic fire detectors and manual call points, physically connected by the means of two-wire connection. The basic configuration of FS5100 includes two lines; the maximum configuration includes eight lines. Up to 32 fire detectors can be integrated into one line.

FIRE CONDITION STAGE I – upon activation of automatic fire detector the fire control panel enters Fire condition until the defined time expires. The common and local light indicators, local sound signaling and a text message displayed on the LCD display indicate the phase.

FIRE CONDITION STAGE II – the fire control panel enters Fire condition stage II when: a) the time for *Fire condition stage I* has expired or b) upon activation of a manual call point. The common and local light indicators, local sound signaling and a text message displayed on the LCD display indicate the phase.

FIRE DETECTOR REMOVED – *non-fatal fault condition* due to removed fire detector in a *line*. To use this function, the fire detectors shall be connected as in Appendix 7 a.

FUNCTION “LOGICAL AND” OF TWO LINES – function that allows the fire control panel to enter *Fire condition stage I* upon simultaneous activation of automatic fire detectors in two *lines*. (see section 6.3).

GROUNDS – *non-fatal fault condition*, due to leakage to a grounded wire.

GROUP ADDRESSING – fire control panel’s ability to make difference between activation of automatic fire detector and manual call point, which are in one and the same *fire alarm line*. For this purpose the manual call points’ current consumption value shall exceed the threshold value for *Fire condition stage II*.

INSPECTION TIME – period of time added to the remaining time, before the system proceeds from *Fire condition stage I* to *Fire condition stage II*, when button  is pressed. Usually, this period of time is long enough for the authorized personnel to check up the indicated premises. The inspection time is user defined and is equal for all *fire alarm lines*. Light indicators show adding a period of time for inspection.

INTERRUPTED LINE OR CONTROLLABLE OUTPUT – *non-fatal fault condition* due to current value in a line or in controllable output lower than the threshold value. The user shall define the threshold value separately for each line.

LINE IN TEST – *line* set in Test condition by the user. The line is powered and reset (the power is cut off for 3 s) periodically every 64 s. The events registered in a line in Test condition are not saved in the archive and do not trigger the associated outputs or the light and sound signalling. The indication for a line in Test condition is common light indication.

LINE STATUS OR CONTROLLABLE OUTPUT STATUS – current status of a *line* or a *controllable output*: normal status; fire conditions stage I or II (for a line only); fault condition and its type.



LOCAL SOUNDER - sounder built-in the fire control panel.

LOW BATTERY – *fatal fault condition* due to full discharge of the backup batteries upon interrupted power supply.

NON-FATAL FAULT CONDITION – fault condition that allows the fire control panel to continue operation. The indication is common light indication, local sound indication and text messages on the LCD display.

PRE-FIRE CONDITION – condition of the fire control panel using the function *Logical AND of two lines* to provide control over simultaneous response of automatic fire detectors in the *lines*. (see section 6.3).

PROCEEDING FROM FIRE CONDITION STAGE I TO FIRE CONDITION STAGE II – the time is user defined for each *fire alarm line* separately. During the phase *Fire condition stage I* the remaining

time for the selected fire alarm line is indicated on the LCD display. During the remaining time actions can be taken, for example press  or .

RELAY OUTPUT – relay, potential free, switching outputs that control external executive devices.

SHORT CIRCUIT IN A LINE OR IN A CONTROLLABLE OUTPUT – *non-fatal fault condition*, entered due to registered current in a *line* or in a *controllable output*, exceeding a threshold value. The threshold value for each line shall be user defined.

SYSTEM ERROR – *fatal fault condition* due to a fault in system's basic component.

SYSTEM OPERATION – the fire control panel executes internal operations to set its registers. This is visualized on the LCD display with a text message for system operations, before the user is allowed to proceed with his work with FS5100.

3. Function

Fire control panel FS5100 is designed to operate with conventional automatic fire detectors and manual call points. The panel has outputs provided for external executive devices. Its modular structure allows for variable configurations according the specific features of the protected site.

4. Technical data

4.1. Modules

4.1.1. Type of modules

- Basic module
- Additional modules:
 - ◆ Module 5101
 - ◆ Module 5102
- Power supply module

4.1.2. Features

- | | |
|--|---|
| <ul style="list-style-type: none"> – Basic module | <ul style="list-style-type: none"> - 2 lines - 2 controllable outputs - 2 relay outputs for fire condition - 1 relay output for fault conditions - interface RS232 / RS485* - power supply for modem* <li style="padding-left: 20px;">* At request |
| <ul style="list-style-type: none"> – Module 5101 | <ul style="list-style-type: none"> - 3 lines - 3 relay outputs for fire condition |
| <ul style="list-style-type: none"> – Module 5102 | <ul style="list-style-type: none"> - 6 lines - 3 relay outputs for fire condition |

4.2. Physical configuration

4.2.1. Basic configuration

- | | |
|--|---|
| <ul style="list-style-type: none"> – Modules | <ul style="list-style-type: none"> - Basic module - Power supply module |
| <ul style="list-style-type: none"> – Features | <ul style="list-style-type: none"> - 2 lines - 2 controllabe outputs - 2 relay outputs for fire condition - 1 relay output for fault conditions |

4.2.2. Expanded configuration

- | | |
|---|--|
| <ul style="list-style-type: none"> – Modules | <ul style="list-style-type: none"> - Basic module - Module 5101 - Power supply module |
|---|--|

- Features
 - 5 lines
 - 2 controllable outputs
 - 5 relay outputs for fire condition
 - 1 relay output for fault conditions
- 4.2.3. Maximum configuration
 - Modules
 - Basic module
 - Module 5102
 - Power supply module
 - Features
 - 8 lines
 - 2 controllable outputs
 - 5 relay outputs for fire condition
 - 1 relay output for fault conditions
- 4.3. Fire alarm lines
 - Maximum number of fire detectors in a line - 32
 - Connecting line - two-wire
 - Maximum resistance of a line - 100Ω
 - Output resistance of a line - 164Ω
- 4.4. Controllable outputs
 - Type - potential
 - Electrical characteristics - (24±5) V/100mA
- 4.5. Common purpose relay outputs
 - Type - potential free, switching
 - Electrical characteristics - 3A/125VAC; 3A/30VDC
- 4.6. Relay output for fault conditions
 - Type - potential free, switching
 - Electrical characteristics - 3A/125VAC; 3A/30VDC
- 4.7. Performance
 - Control over fire alarm lines and controllable outputs for fault conditions (short circuit and interruption) and automatic reset.
 - Detection of removed fire detector and automatic reset.
 - Ability to set the lines in dependency of the function “Logical AND”
 - Group addressing of manual call points and automatic fire detectors
 - Two phases of Fire condition, programmable time for Fire condition stage I, separately for each line
 - Option to prolong the time period for Fire condition stage I with programmable overall inspection period
 - Built-in sounder for fire condition – one tonal, continuous, can be switched off
 - Built-in sounder for fault condition – one tonal, discontinuous, can be switched off
 - Built-in real time clock
 - Set of test modes and options for adjustment:
 - ◆ Setting the clock;
 - ◆ Check up of light and sound indications;
 - ◆ Test of fire alarm lines;
 - ◆ Adjustment of outputs and the integrated external devices;
 - ◆ Measuring the current value in the fire alarm lines;
 - ◆ Programming of parameters and modes of operation;
 - ◆ Remote programming of the parameters from distant operator control point.
 - Energy independent archive of registered events with the events type, date and hour – up to 84 events
 - Communication interface for external devices – RS-232 (directly or via modem) or RS-485

4.8. Indications of registered events

- Light indication - LED
- Text messages - LCD display - 1 line, 16 symbols, Latin/Cyrillic characters, backlit
- Sound - built-in sounder

4.9. Power supply

4.9.1. Mains

- Voltage - 220/230V
- Frequency - 50Hz

4.9.2. Backup batteries

- Battery type - lead, gel electrolyte
- Number of batteries - 2 pcs
- Connection - serial connection
- Nominal voltage of the backup battery - 24V
- Nominal capacity C_{20} - 7Ah
- Extreme discharge voltage - 21V
- Charge voltage - 28,2V

4.9.3. Consumption on backup batteries supply

- Basic configuration - < 150mA at 24V
- Expanded configuration - < 185mA at 24V
- Maximum configuration - < 220mA at 24V

4.9.4. Power supply to external devices

- Voltage - (24±5)V
- Maximum current value (including current of controllable outputs) - 1,3A

4.10. Dimensions

- Dimensions up to - 445x327x87mm

4.11. Weight

- backup batteries not included - 5,2kg

5. Contents of delivery

5.1. Fire control panel

- Fire control panel FS5100 - 1 pc
- Resistors 3,9kΩ/ 0,25W
 - ◆ Basic configuration - 2 pcs
 - ◆ Expanded configuration - 5 pcs
 - ◆ Maximum configuration - 8 pcs
- Resistors 5,6kΩ/ 0,25W - 2 pcs
- Jumper for the backup batteries - 1 pc
- Fuse 4A - 2 pc
- Instruction manual - 1 pc
- Authorized staff instruction - 1 pc
- Packing - 1 pc

5.2. Additional module

- Module 5101 or 5102 - 1 pc
- Resistors 3,9kΩ/ 0,25W
 - ◆ For Module 5101 - 3 pcs
 - ◆ For Module 5102 - 6 pcs
- Screw M3 - 1 pc

6. General information

6.1. Access levels

There are 4 levels of access to the variable indications and control functions of FS5100.

6.1.1. Access level 1

All persons who would presumably find out and react to alarm for fault condition or fire condition have access to level 1.

The following features are accessible:

- Displaying suppressed messages for Fire condition, Fault condition and Disabled lines (see sections 8, 10 and 11);
- Entering inspection time period (see section 8);
- Forced proceeding from phase Fire condition stage I to phase Fire condition stage II (see section 8);
- Displaying the status of the lines and of the controllable outputs (see section 13).

All light indicators are visible.

6.1.2. Access level 2

The personnel in charge for the fire protection have access to level 2; they shall be authorized and trained to operate the fire control panel in the following conditions:

- Duty Mode;
- Fire condition;
- Pre-Fire condition;
- Fault condition;
- Disabled component;
- Information and adjustment.

To enter Access level 2, insert the key into the front panel in position .

The following features of the fire control panel are accessible:

- All features accessible at Level 1;
- Suppression of the local sounder and switching off the outputs, activated upon fire condition (see sections 8, 9 and 10);
- Exit of Fire condition (see section 8);
- System functions of the fire control panel without entering SetUp Mode (see section 13).

6.1.3. Access level 3

Accessible for personnel trained and authorized for:

- Reconfiguration of specific data – of the protected site or of the fire control panel – saved in the memory;
- Maintenance of the fire control panel.

This level has two sublevels of access - 3A and 3B.

Level 3, sublevel 3A, is accessed through a password, entered at Access level 2. At this sublevel the functions for reconfiguration of specific data for the protected site or the fire control panel are accessible. (See section 14).

Level 3, sublevel 3B is accessed when the fire control panel is opened. The following features are accessible:

- Replacing a burnt fuse;
- Adding, removing and replacing an additional module;
- Connecting fire alarm lines and executive devices.

6.1.4. Access level 4

Accessible for trained and authorized by the Producer personnel to repair the fire control panel and to modify the software. Special means are required to enter this level.

6.2. Indications and buttons for control

Table 1 gives detail description of the indications for each status, Table 2 presents the basic means for control. Appendix 1 shows the front panel of Fire control panel FS5100 with its visual system for indication and control.

Table 1

























Conditions of the fire control panel	Indication
All conditions - The fire control panel is power supplied	 Indicator <i>Power supply</i> – continuous green light
Fire condition, phase Fire condition stage I	 Common indicator <i>Fire condition stage I</i> – flashing red light
Fire condition, phase Fire condition stage II	 Common indicator <i>Fire condition stage II</i> – flashing red light
Fire condition in indicated lines	Separate indicators for fire condition – flashing red light
Pre-Fire condition in indicated lines	Separate indicators for fire condition – continuous red light
Fire condition, phase Fire condition stage I – inspection time has been entered	 Indicator <i>Inspection</i> – continuous green light
Fire condition and Fault condition - sounders and outputs for fire condition has been suppressed	 Indicator <i>Stop Alarm</i> – continuous red light
SetUp and Remote control; Fault condition – System error	 Common indicator <i>Fault condition</i> – continuous yellow light
Fault condition - All faults except for System error and Low battery due to interrupted mains supply	 Common indicator <i>Fault condition</i> – flashing yellow light
Fault condition – System error and Circuit boards conflict	 Indicator <i>System error</i> - continuous yellow light
Fault condition - Fault in mains supply	 Indicator <i>Fault in main supply</i> - flashing yellow light
Fault condition - Fault in the backup batteries or in the charger	 Indicator <i>Backup battery fault</i> - flashing yellow light
Fault condition - Fault in a controllable output	 Indicator <i>Out of order/Disabled controllable output</i> – flashing yellow light
Disabled component - Disabled controllable output	 Indicator <i>Out of order/Disabled controllable output</i> – continuous yellow light
Disabled component - Disabled line or controllable output	 Indicator <i>Disabled component</i> - continuous yellow light
Test condition	 Indicator <i>Test</i> – continuous yellow light
Fire condition; Fault – System error	Local sounder – continuous signal
Pre-Fire condition	Local sounder – discontinuous signal: 4 sound impulses for 1s, followed by 1s break
Fault condition - All faults except for System error and Low battery due to interrupted mains supply	Local sounder – discontinuous signal: 1s sound 1s break
Fault condition - Low battery due to interrupted mains supply	Local sounder – discontinuous signal: 1s sound 3s break

Table 2

Means of control	Condition of the fire control panel	Access level	Operation
Key for access to Level 2		Level 1	Position 
		Level 2	Position 
Button <i>Reset of line</i> 	Fire condition	Level 2	To exit Fire condition in a line, indicated on the LDC display
Button <i>Inspection</i> 	Fire condition stage I	Levels 1 and 2	To add time period for inspection
Button <i>Stop Alarm</i> 	Fire condition and Fault condition*	Level 2	To suppress the local sounder and switch off the outputs for fire condition
Button <i>Start Alarm</i> 	Fire condition and Fault condition*	Level 2	To cancel the action of <i>Stop Alarm</i>
	Fire condition	Levels 1 and 2	To force the transition from Fire condition stage I to Fire condition stage II
Button <i>Menu</i> 	Duty mode, Fire condition, Pre-Fire condition, Fault condition*, Test mode and Disabled component	Levels 1 and 2	To enter Information and Control mode
	Information and control	Levels 1 and 2	- To enter the selected menu - To execute the selected command
	SetUp	Level 3A	- To save a modified parameter
Button <i>Down</i> 	Fire condition	Levels 1 and 2	To display the first or the next message for fire condition
	Information and control	Levels 1 and 2	- To display the next element of the menu - To move the cursor
	SetUp	Level 3A	- To modify the selected parameter
Button <i>Up</i> 	Fault condition*	Levels 1 and 2	To display the first or the next message for a fault condition
	Information and control	Levels 1 and 2	- To display the previous element of the menu
	SetUp	Level 3A	- To modify the selected parameter
Button <i>Cancel</i> 	Disabled component	Levels 1 and 2	To display message for disabled lines, if any
	Information and control	Levels 1 and 2	- To exit a function without saving changes in the parameter; the command will not be executed
	SetUp	Level 3A	- To exit the current menu and to move to an upper hierarchy menu

* Not active in fault condition – System error and Low backup battery due to interrupted mains supply

6.3. Function “Logical AND” of two lines

The function *Logical AND* gives the opportunity to form the following dependence between two lines: the fire control panel will enter Fire condition, phase Fire condition stage I, using each of the line (or both of them) upon activation of fire detectors in both lines.

The function does not affect manual call points. Upon activation of a manual call point (value of the line current between Fire condition stage II and Short circuit) in a line, dependent on function “Logical AND”, the fire control panel will enter Fire condition stage II in this line.

Upon activation of automatic fire detector (value of the line current between Fire condition stage I and Fire condition stage II) in a line that is in Logical AND dependency by another line the fire control panel will enter

- Pre-Fire condition in this line – if there is no activated automatic fire detector or manual call point in the other line;
- Fire condition, phase Fire condition stage I in this line – if there is an activated manual call point in the other line, i.e. the fire control panel has already entered Fire condition, phase Fire condition stage II in the other line;
- Fire condition stage I in both lines – if there is an activated automatic fire detector in the other line, i.e. the fire control panel has already entered Pre-Fire condition in the other line.

Exit from Pre-Fire condition in a line is done automatically only:

- Upon activation of automatic fire detector in a line that has settled dependence to a particular line according the function “Logical AND”, within 60 s after entering Pre-Fire condition, the fire control panel enters Fire condition stage I in both lines;
- Upon activation of manual call point in the line that has settled dependence to a particular line according the function “Logical AND”, within 60 s after entering Pre-Fire condition, the fire control panel enters Fire condition stage I in this particular line, and Fire condition stage II in the first line;
- Upon increased current value in a line within the limits between current values for Fire condition stage II and Short circuit the fire control panel enters Fire condition stage II in this line;
- Where the 60 s of Pre-Fire condition expire and none of the above mentioned three conditions is carried out, the fire control panel exits Pre-Fire condition in this line and is reset – the power supply is interrupted for 3 s thus the activated automatic fire detectors in this line shall be reset.

To settle dependence of two lines on function “Logical AND”, set the parameter “Logical AND” in one of the lines. (see section 14.2.2).

When using the “Logical AND” in two lines, we recommend one of the two methods:

- Outputs for fire condition shall be associated to one line only, where manual call points, if necessary, are already integrated;
- The same outputs for fire condition shall be associated to both lines (equal for both Fire condition stage I and II); in this case manual call points can be integrated in both lines.

6.4. Conditions of the fire control panel

FS5100 monitors the fire alarm lines by consecutively scanning their condition. Depending on the current value, the line can be in normal condition, in fire condition or in a fault condition (short circuit or break). Simultaneously, a constant control over the controllable outputs of fault condition (short circuit or break) is being carried out.

The fire control panel FS5100 operates in nine basic modes: Duty Mode, Fire Condition, Pre-Fire Condition, Fault Condition, Disabled Component Mode, Test Mode, Information and Control Mode, SetUp Mode and Remote Control Mode.

In each moment the control panel can be in one or in a combination of these conditions: Fire Condition, Pre-Fire Condition, Fault Condition, Disabled Component Mode, Test Mode and Information and Control Mode. In Information and Control Mode text messages for other conditions are being suppressed. Every time the fire control panel enters Fire Condition or Fault Condition, it exits Information and Control Mode.

Duty Mode, SetUp Mode and Remote Control Mode cannot be combined with another condition:

- The fire control panel enters Duty Mode after it has exited all other modes;
- When the fire control panel enters SetUp Mode or Remote Control Mode it exits all other conditions.

7. Duty Mode

7.1. Description

The fire control panel is in Duty Mode, when it is not in any other of the rest 8 possible conditions.

7.2. Indication

7.2.1. LED and sound indication

In Duty Mode the green LED indicator is activated  (Power supply). The local sounder is off.

7.2.2. Text message

Message *Duty* and the current time are displayed on the LCD display



7.3. Using the keypad

The only accessible button in Duty Mode is  (Menu). Press it and the fire control panel enters Information and Control Mode.

8. Fire Condition

8.1. Description

The fire control panel enters Fire Condition after a fire detector has been activated in one of the fire alarm lines. The condition has two phases – Fire condition stage I and Fire condition stage II. The time period for Fire condition stage I is limited and is user programmable, separately for each line (up to 255 seconds). The period can be prolonged with the Inspection time (see section 8.3.1). When Fire condition stage I in one line expires, the fire control panel enters Fire condition stage II in the same line.

The fire control panel enters Fire condition stage I upon activation of an automatic fire detector when the current value in the line is between the limits for Fire condition stage I and Fire condition stage II. The fire control panel enters Fire condition stage II upon activation of a manual call point when the current in the line is between the limits for Fire condition stage I and Short circuit. All threshold values are user defined, separately for each line. (see sections 14 and 14.2.2).

The fire control panel can be in Fire Condition in one or more lines. When the fire control panel is in Fire Condition in several lines, it can be in Fire condition stage I in part of the lines, and in Fire condition stage II in the rest of the lines.

To exit this condition press button  at Access level 2 (see section 8.3.4) for each fire alarm line in fire condition.

8.2. Indication

8.2.1. LED and sound indication

In this condition the common light indicator  (Fire condition stage I) and/or  (Fire condition stage II) and the local indicators for fire condition in all lines in fire condition flash in red.

If Inspection time has been entered, the indicator  illuminates in continuous green light (Inspection).

The local sounder produces continuous signal. If the sound indication has been suppressed by button  (Stop alarm), the LED indicator on the button illuminates in continuous red light.

8.2.2. Text messages

For a line in Fire condition stage I the following message appears on the display:

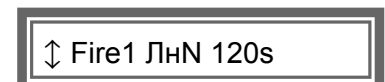

where N is the number of the line. At the end of the message is displayed the time, remaining to the next phase. Where Inspection time has been entered, the remaining time is displayed only if it is less than 255 seconds.

The first symbol has the following meaning:

- empty – only one line is in Fire condition;
- “↓” – for the last line that entered Fire condition;
- “↑” – for the first line that entered Fire condition;
- “↕” – for the rest of the lines that entered Fire condition.

For a line in Fire condition stage II the following message appears on the display:



where N is the number of the line. In this case remaining time is not displayed. The first symbol has the same meaning as it does in Fire condition stage I.

The messages for fire condition have a priority order. The message for the last line that has entered fire condition is of highest priority; the message for the first line is of lowest priority. The highest priority message suppresses all other messages. Access to all suppressed messages is provided via keypad (see section 8.3.5). Additional information is obtained from the LED indicators.

8.3. Using the keypad

8.3.1. Button (Inspection)

When you press the Inspection button, the time period, already programmed by the user, will be added to the remaining time for all lines before they proceed to Fire condition stage II.

The button is active when a fire alarm line enters Fire condition stage I.

8.3.2. Button (Stop alarm)

Press it to:

- Switch off the local sounder for fire condition/pre-fire condition where the fire control panel has entered Fire condition or Pre-Fire condition in a line (lines);
- Switch off the local sounder for Fault condition upon fault condition;
- Switch off the outputs, associated to the lines in Fire condition;
- Illuminate the LED indicator of the button, if signalizations or outputs for Fire condition have been switched off.

The button does not affect and is not influenced by the following events:

- When a new line enters Fire condition or proceeds from Fire condition stage I to Fire condition stage II, the local sounder will be activated for Fire condition/Pre-Fire condition and the outputs associated to these lines only will be switched on;
- When a new line enters Pre-Fire condition the local sounder will be activated for Fire condition/Pre-Fire condition only;
- A new Fault condition will trigger the local sounder for Fault condition only.

The LED indicator of the button stays illuminated, if the signalizations and/or the outputs remain off.

The button is active at Access level 2 (the key on the front panel is in position ).

8.3.3. Button (Start Alarm)

It forces the proceeding to Fire condition stage II of all fire alarm lines, which have entered Fire condition stage I, and triggers the local sounder for Fire condition/Pre-Fire condition.



At Access level 2 the action of button  can be cancelled. The signalizations are triggered and the outputs, switched off by this button, are switched on, and the LED indicator extinguishes.

8.3.4. Button (Reset of line)

It forces the fire control panel to exit Fire condition in the line, indicated on the LCD display, and resets the line (cuts off the power supply for 3 seconds).

The button is active at Access level 2 (the key on the front panel is in position ).

8.3.5. Buttons (Down), (Up) and (Cancel)

If there are suppressed messages, they can be displayed using buttons ,  and  situated on the front panel.

The priority of the messages is:

- Messages for lines in Fire condition are of highest priority;
- Messages for Fault conditions;
- Messages for disabled lines are of lowest priority.

The messages inside these three groups are also set by priority; it is explained in the definitions for the corresponding conditions (see sections 8.2.2 and 10.2.2).

If there are suppressed messages for fire condition, press the button  to display:

- The message for fire condition that has highest priority, if before it a message for fault condition or disabled lines is displayed;
- The next message that has lower priority, if before it a message for fire condition is displayed.

When the lowest priority message is reached, button  will display the highest priority message.

If there are suppressed messages for fault condition, button  will display:

- The highest priority message, if before it is displayed a message for fire condition or for disabled lines;
- The next message of lower priority. When the message of lowest priority is reached, if you

press button  the message of highest priority will be displayed.

If there is a suppressed message for disabled lines, it will be displayed by pressing button .

When the suppressed message is displayed, 15s after the last pressing of the button the message of highest priority will be automatically restored.

8.3.6. Button (Menu)

Press the button to enter Information and Control Mode.

9. Pre-Fire Condition

9.1. Description

Pre-Fire condition ensures the correct operation of the Function “Logical AND” for two lines. (see section 6.3).

9.2. Indication

9.2.1. LED and sound indication

The local indicator for fire condition illuminates in continuous red light to indicate that the fire control panel has entered Pre-Fire condition in this line.

The local sounder emits discontinuous asymmetrical signal - 4 sound impulses for a second, then pause for 1s. If the sound indication has been suppressed by button  (Stop Alarm), the LED indicator on the button illuminates in steady red light.

9.2.2. Text messages

The message Duty and the real time are displayed on the LCD display.



This message can be suppressed from the screens for Fire Condition, Fault Condition and Disabled Component Mode, or Disabled lines. (see section 6.4).

9.3. Using the keypad

Pre-Fire condition supports 3 active buttons. When the fire control panel operates in combination of other conditions, their buttons are active too.

9.3.1. Button (Stop Alarm)

Press the button to:

- Switch off the local sounder for fire condition/pre-fire condition, if there are fire alarm lines, in which the fire control panel has detected Fire Condition or Pre-Fire Condition;
- Switch off the local sounder for fault condition when a Fault Condition is detected;
- Switch off the outputs associated to the lines in Fire Condition;
- Switch on the LED indicator of the button, if signaling or outputs for fire condition have been switched off.

The button does not affect nor is its action cancelled by the following events:

- When Fire Condition is registered in a new line, or transition from Fire condition stage I to Fire condition stage II shall activate the local sounder for Fire/Pre-Fire condition and shall switch on the lines associated to the corresponding outputs;
- When Pre-Fire Condition is registered in a new line, the local sounder for Fire/Pre-Fire condition shall be activated;
- A new Fault condition shall activate the local sounder for Fault condition only.

The button's LED indicator remains illuminated if the signalization and/or outputs remain off.

The button is active at Access level 2 (the key on the front panel is in position .

9.3.2. Button (Start Alarm)

Press the button (at Access level 2) to cancel the operation of button , i.e. the signalization and the outputs that have been switched off by this button are activated and its LED indicator is extinguished.

Note: When the fire control panel operates in a combination of Pre-Fire condition and Fire condition, the button triggers other operations.(see section 8.3.3).

9.3.3. Button (Menu)

Press the button to enter Information and Control Mode.

10. Fault Condition

10.1. Description

The fire control panel enters Fault Condition when any of the events below has been registered:

- System error;
- Circuit boards conflict;
- Backup batteries discharged due to mains supply interruption;
- Fault in a line – removed fire detector, short circuit or break;
- Fault in a controllable output – short circuit or break;
- Fault in main supply;
- Fault in backup batteries power supply;
- Fault in external devices power supply;
- Short circuit in grounded wire;
- Fault in internal power supply;
- Fault in the charger.

The *System error* is a fatal error – the fire control panel does not service lines, outputs either peripherals. You can exit the fault condition if you disconnect the control panel from the main supply and send it for repairs.

The *Circuit boards conflict* is also a fatal error, but you can exit the condition by entering SetUp Mode. Such fault condition occurs usually after modification of the physical configuration of the fire control panel – addition, removal or replacement of additional module.

The *discharge of the backup batteries due to mains supply interruption* is also a fatal error – all lines and outputs are not being serviced. The fire control panel gets into the following special status:

- Discontinuous sound signal is released - 1s sound, 3s pause, for at least an hour;
- Only the green LED indicator is illuminated  (*Power supply*);
- The backlight of the display is extinguished;
- Only the power supplies are being controlled.

The fire control panel exits the status automatically 8 s after the mains supply is restored.

All other faults are not fatal and switch off some of the periphery devices only. The fire control panel exits such conditions automatically 8 s after the breakdown is eliminated.



Upon *Short circuit in ground wire* occur the following faults:

- Fault Condition in a line (fire detector removed) – where the short circuit is in fire alarm line's component;
- Fault Condition in controllable output (interruption) – where the short circuit is in a component of a controllable output.

In Fault Condition the relevant messages are shown on the display. Additional information is acquired from the LED indication.

10.2. Indication





10.2.1. LED and sound indication

Upon System error the indicators  (Fault condition) and  (System error) illuminate in continuous yellow light. The local sounder is activated and releases permanent sound signal.

Note: If the processor has stopped operation the common indicator for Fault condition is not illuminated and no text message is displayed on the LCD.

In *Low battery due to interrupted mains supply* no LED indicator is illuminated. The local sounder produces discontinuous sound (1 s sound, 3 s pause). The backlight of the LCD is off.

In all other fault conditions the indicator  (Fault condition) flashes in yellow. Depending on the type of the fault condition the following indicators are illuminated:

- Circuit boards conflict – indicator  (System error) is illuminated in continuous yellow light;
- Fault in controllable output - indicator  (Out of order / Disabled controllable output) flashes in yellow light.
- Fault in mains supply - indicator  (Fault in mains supply) flashes in yellow light;
- Fault in backup batteries - indicator  (Backup battery fault) flashes in yellow light.

The local sounder is activated and produces discontinuous signal. If the sound indication has been suppressed by button  (Stop Alarm), the LED indicator on the button illuminates in steady red light.

10.2.2. Text messages

The messages for fault condition have a priority order, as ranged in section 10.1. The messages for fatal errors suppress all other messages; the messages for non-fatal errors suppress all other messages except for these for Fire Condition. If more than one non-fatal error has been detected, they are indicated according priority; the message of highest priority suppresses all other messages except for these for Fire Condition (see section 6.4)

10.2.2.1. The following messages are displayed upon detection of fatal errors:

- * System error N, where N is error's number giving information for the authorized specialist.

The message suppresses all other messages and can not be suppressed.

- * Circuit boards conflict

The message suppresses all other text messages except for System error message (see section 6.4).

Syst Error	N
------------	---

Boards Conflict

- * Low battery due to interrupted mains supply.
The message suppresses all other text messages except for System error message and can not be suppressed.



10.2.2.2. The following messages are displayed upon detection of non-fatal errors.

- * Fault in a line
The right screen section "12345678" contains the number of the lines in fault condition.
- * Fault in controllable output
The right screen section "12" contains the number of the controllable outputs in fault condition.
- * Fault in mains power supply
The backlight of the LCD is extinguished and is activated only if a button is pressed. 15 s after that the light is extinguished again.
- * Backup battery fault.
- * Fault in external devices power supply
- * Short circuit in ground wire
- * Fault in internal power supply
- * Fault in the charger



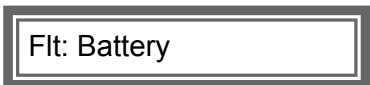



10.3. Using the keypad

In *System error* and in *Low battery due to interrupted mains supply* conditions none of the buttons is active. For the rest of the fault conditions 6 active buttons are supported. When the fire control panel operates in combination of other conditions, their buttons are active too.

10.3.1. Button (Stop Alarm)

Press the button to:

- Switch off the local sounder for fire condition/pre-fire condition, if there are fire alarm lines, in Fire Condition or Pre-Fire Condition;
- Switch off the local sounder for fault condition when a Fault Condition is detected;
- Switch off the outputs associated to the lines in Fire Condition;
- Switch on the LED indicator of the button, if signaling or outputs for fire condition have been switched off.

The button does not affect nor is its action cancelled by the following events:

- When Fire Condition is registered in a new line, or transition from Fire condition stage I to Fire condition stage II shall activate the local sounder for Fire/Pre-Fire condition and shall switch on the lines associated to the corresponding outputs;
- When Pre-Fire Condition is registered in a new line, the local sounder for Fire/Pre-Fire condition shall be activated;
- A new Fault condition shall activate the local sounder for Fault condition only.

The button's LED indicator remains illuminated if the signalization and/or outputs remain off.



The button is active at Access level 2 (the key on the front panel is in position ).

10.3.2. Button (Start Alarm)

Press the button (at Access level 2) to cancel the operation of button , i.e. the signalization and the outputs that have been switched off by this button are activated and its LED indicator is extinguished.

Note: When the fire control panel operates in a combination of Pre-Fire condition and Fire condition, the button triggers other operations (see section 8.3.3).

10.3.3. Buttons , (Down), (Up) and (Cancel)

If there are suppressed messages, they can be displayed using buttons ,  and  situated on the front panel. They operate as in Fire Condition (see section 8.3.5).

When the suppressed message is displayed, 15s after the last pressing of the button the message of highest priority will be automatically restored.

10.3.4. Button (Menu)

Press the button to enter Information and Control Mode.

11. Disabled Component Mode

11.1. Description



The fire control panel enters Disabled Component Mode after a component has been manually disabled – a fire alarm line or a controllable output. The condition is controlled via the screens of Information and Control Mode (see sections 13.2.3 and 13.2.4). The disabled line is switched off (the power supply is cut off) and is not monitored for activated fire detector and faults. The disabled controllable output is switched off (the executive device can not operate) and is not monitored for faults.

In case of disabled fire alarm lines a relevant message is shown on the display.

Additional information is acquired from the LED indicators.

11.2. Indication

11.2.1. LED and sound indication

In such condition the common indicator  (Disabled component) illuminates in steady yellow light. If there are disabled controllable outputs the indicator  (Out of order/Disabled controllable output) illuminates in steady yellow light. The indication can be suppressed by indication for a fault in controllable output; the indicator will then flash in yellow (see 10.2.1).

No sound indication is supported for Disabled Component Mode.

11.2.2. Text messages

If there are disabled lines the following text message is displayed:

Dsbl Ln	12345678
---------	----------

The right screen section “12345678” contains the numbers of the disabled lines.

The message suppresses all other messages except for these for Fire Condition and Fault Condition (see section 6.4).



If there are disabled controllable outputs, but no fire alarm lines have been disabled, the message *Duty* and the real time are displayed.



Duty	17:05:34
------	----------

The message can be suppressed from the screens for Fire Condition, Fault Condition, Disabled Component and Disabled Lines (see section 6.4). To check for any disabled lines go to Disabled controllable outputs from the first menu of Information and Control Mode (see section 13.3).

11.3. Using the keypad

Disabled component supports 4 active buttons. When the fire control panel operates in combination of other conditions, their buttons are active too.

11.3.1. Buttons  (Down),  (Up) and  (Cancel)

If there are suppressed messages, they can be displayed using buttons ,  and  situated on the front panel. They operate as in Fire Condition (see section 8.3.5).

When the suppressed message is displayed, 15s after the last pressing of the button the message of highest priority will be automatically restored.

11.3.2. Button  (Menu)

Press the button to enter Information and Control Mode.

12. Test Mode

12.1. Description

The fire control panel enters Test Mode after a fire alarm line has been manually set to operate in test condition. The mode can be controlled via the screens for Information and Control Mode (see section 13.2.2).

When a fire alarm line is in test condition, the following operational changes are in effect:

- Upon registration of Fire condition stage I or Fire condition stage II in this line the sound indications, light indications, associated controllable and relay outputs do not operate – i.e. the fire control panel does not enter Fire Condition;
- Upon registration of Fault in a line the sound indicators, light indicators and the relay output for fault condition do not operate – i.e. the fire control panel does not enter Fault Condition;
- The events registered in the line are not saved in the energy independent memory;
- The line is being automatically reset (the power supply is interrupted for 3 s) every 64s.

12.2. Indications

12.2.1. LED and sound indication

The common indicator  (Test) illuminates in steady yellow light. Sound signaling is not supported.

12.2.2. Text messages

When Test Mode is not in combination with another condition, the message *Duty* and the real time are displayed on the LCD:



The message can be suppressed from the screens for Fire Condition, Fault Condition, Disabled Components; Disables Lines (see section 6.4).

12.3. Using the keypad

Test Mode supports 1 active button. When the fire control panel operates in combination of other conditions, their buttons are active too.



When the message for Test Mode is displayed, the button  (Menu) is active. Press it to enter Information and Control Mode.

13. Information and Control Mode

13.1. Description

Information and Control Mode enables the user to display information on the fire control panel and to enter data for control.

To enter the Information and control Mode press button  from the screens for Duty Mode, Fire Condition, Pre-Fire Condition, Fault Condition (except for *System error* and *Low battery due to interrupted mains supply*), Test Mode and Disabled Component; their messages will be suppressed (see section 6.4). When the fire control panel operates in combination of other conditions, their

buttons are not active, except for button  (Stop Alarm) and button  (Start Alarm).

The Information and Control Mode does not support any specific LED or sound indication.

The screens displayed on the LCD are organized in a tree structure of subordinate menus (Appendix 8). Transition to a menu of successive (lower) level is performed by pressing the button



; transition to a menu of previous (higher) level is performed by pressing the button







Moving between menus of one and the same level is performed by pressing the buttons



The screens containing particular information (information screens) or permitting parameters change and command execution (command screens) are on the last (lowest) level.

On information screens the button  is not active; the rest three buttons retain their functions. When a command screen is activated, a cursor appears. In this case the buttons have the following effect:

- Press button  to save a change in a parameter or to execute a selected command; afterwards the screen is deactivated and the cursor disappears (differences in button's effect in some cases are explicitly stated);
- Press button  to deactivate the screen without saving any changes or without execution of the relevant command; the cursor disappears;
- Button  is active only on screens for parameter change, when the cursor selects a digit. Press it to move the cursor with one position to the right. When the last right position of the parameter is reached the cursor moves to its first position;
- Button  is active only on screens for parameter change. Press it to increase the selected digit or to increase the parameter to the next possible rate (when the cursor is to the right of the parameter). In both cases, when the maximum possible rate is reached, a transition to the lowest possible rate is made.

When the fire control panel enters Information and Control Mode a transition to the first menu is made. The menu contains the following subordinate menus and information screen:

- System functions (subordinate menu);
- Disabled controllable outputs (information screen);
- Status (subordinate menu).

13.2. Menu *System functions*

Screen for selection:



The menu contains the following subordinate menus and functions:

- LED and sound indicators check up;
- Fire alarm lines test;
- Disable fire alarm lines;
- Disable controllable outputs;
- Current in the lines;
- Setting the real time clock;
- Parameters check;
- Adjustment;
- Archive review.

The subordinate menus can be entered at Access level 2, i.e. when the key on the front panel is turned to position .



13.2.1. Function *LED and sound indicators check up*

Screen for activation:

Indicators check

To activate the function press button , and a cursor appears on the screen:

Indicators check

When the button  is pressed, all LED indicators illuminate and the sound indicator releases continuous sound signal as long as the button is being pressed. To deactivate the function press button ; the cursor disappears.

13.2.2. Function *Fire alarm lines test*

The function is activated from the screen





Test Ln

When the function is active, the following command screen appears, where X can be 0 (fire alarm line not in test condition) or 1 (fire alarm line in test condition):

Test Ln XXXXXXX

The first position corresponds to Line 1, the last position corresponds to Line 8.

Press the button  to move the cursor one position to the right; when the last (eighth fire alarm line) position is reached the cursor moves to position one (first fire alarm line)

Press the button  to alternatively change the value from 0 to 1 and vice versa, of the position selected by the cursor. The changes (fire alarm line set to test condition or out of test condition) become valid when button  is pressed; the function is not deactivated then. To deactivate it press  or press once again .

Press  to activate all outputs (controllable and relay outputs), which operate in Fire Condition stage I or II in all lines in test condition. The outputs are active until the button is being pressed. The button operates upon activated function *Fire alarm lines test* and upon absence of unaccepted changes, i.e. if:

- no changes are made after the function has been activated or
- changes have been entered by a single pressing of ; the function is not deactivated.

13.2.3. Function *Disable fire alarm lines*

The function is activated from the screen

Dsbl Ln

When the function is active, the following command screen appears, where X can be 0 (fire alarm line is enabled) or 1 (fire alarm line is disabled):

Dsbl Ln XXXXXXX

The first position corresponds to Line 1, the last position corresponds to Line 8.

13.2.4. Function *Disable controllable outputs*

The function is activated from the screen:

Dsbl cO

When the function is active, the following command screen appears, where X can be 0 (controllable output is enabled) or 1 (controllable output is disabled):

Dsbl cO XX

The left position corresponds to Controllabel output 1.

13.2.5. Menu *Current in fire alarm lines*
 Select the menu from the screen:



Information screens for current in lines appears; N is the number of the selected fire alarm line, the current is in mA:



13.2.6. Menu *Setting the clock*
 Select the menu from the screen:



The menu has the following functions:
 - Setting the date
 - Setting the time

13.2.6.1. Function *Setting the date*

Activate the function from the screen
 (DD is the current date, MM is the current month, YY is the current year)



When the function is active the following cursor appear over the left digit DD.



When the desired date is set, press  and the function is deactivated if the data is correctly entered. If the entered data is wrong, the screen remains unchanged and the cursor is positioned over the first digit of the wrong parameter (for example, *month 13*).

13.2.6.2. Function *Setting the time*

Activate the function from the screen
 (HH is for the hour, MM is for the minutes and SS – the seconds)



When the function is active the following cursor appear over the left digit HH.



When the desired time is set press  and the function is deactivated if the data is correctly set. If the entered data is wrong, the screen remains unchanged and the cursor is positioned over the first digit of the wrong parameter. (for example *hour 25*)

13.2.6.3. Function *Calibration*

Activate the function from the screen
 (The “s” field contains the sign of the calibration: + or -; the “CC” field displays the calibration value)



Upon activation a cursor appears at the end of the line:



Each positive sign character accelerates the clock with 10.7 s per month; each negative sign character delays the clock with 5.35 s per month. The maximum calibration per month is + 5.5 min or – 2.75 min. When the desired time is set, press  and the function will be deactivated.

13.2.7. Menu *Parameter review*

Select the menu from the screen

Param Review

The menu contains subordinate menus:

- Boards
- Lines parameters
- Fire control panel parameters

13.2.7.1. Menu *Boards*

Select the menu from the screen

Boards

The menu contains one information screen only:
N is the type of the integrated additional module.

Boards N

N can adopt the following values:

- "NO" – without additional module
- "1" - Module 5101;
- "2" - Module 5102.

13.2.7.2. Menu *Line parameters*

Select the menu from the screen

Line

The menu contains 8 subordinate menus, one for each line.

Enter the menu to display the screen of the subordinate menu for Line 1 and select the desired line.

Line 1

Each subordinate menu contains information screens for the following line parameters:

- Number of confirmation checks upon detection of level Fire Condition:

(N is the number of the checks - 1 to 3)

Frequent (two or three) check ups are set for fire detectors that shall respond two or three times before a decision for a Fire Condition is taken. In this case the time for the second and the third check up is included in the fire detector's response period, not in the fire control panel's response period.

- Check up for a removed fire detectors:

(At N=0 no check up for a removed fire detectors is made, at N=1 a check up is being made)

The check up is possible when the fire detectors are connected according the diagram in Appendix 7a. The check up is made every 8 s, as the fire alarm line is subject to voltage 5V and reverse polarity;

- Period for transition from Fire condition stage I to Fire condition stage II:

(SSS is the time period in seconds - 0 to 255s);

- Current threshold above which Fire condition stage I is detected in a line:

(CCC is the current in mA - 1 to 80mA);

- Current threshold above which Fire condition stage II is detected in a line:

(CCC is the current in mA - 1 to 80mA);

- Current threshold above which Short circuit is detected in a line:

(CCC is the current in mA - 1 to 80mA);

Nmbr Checks N

Removed FD N

Tm F1 – F2 SSSs

Crr F1 CCCmA

Crr F2 CCCmA

Crr Short CCCmA

- Current threshold below which Interruption in a line is detected:
(CCC is the current in mA - 1 to 80mA);
- Logical AND dependency of a line:
(At N=0 the current fire alarm line is not in Logical AND dependency of another line, at N=1 to 8 the current fire alarm line is in Logical AND dependency of a line having this number (see section 6.3);
- Controllable outputs upon Fire condition stage I in a line:
(At X=0 the controllable output does not start operation upon Fire condition stage I, at X=1 the controllable output starts operation)
The left position corresponds to Controllable output 1;
- Controllable outputs upon Fire condition stage II in a line:
(At X=0 the controllable output does not start operation upon Fire condition stage II, at X=1 the controllable output starts operation)
The left position corresponds to Controllable output 1;
- Relay outputs upon Fire condition stage I in a line:
(At X=0 the relay output does not start operation upon Fire condition stage I, at X=1 the relay output starts operation)
The left position corresponds to relay output 1;
- Relay outputs upon Fire condition stage II in a line:
(At X=0 the relay output does not start operation upon Fire condition stage II, at X=1 the relay output starts operation)
The left position corresponds to relay output 1.

Crr Intrr	CCCmA
-----------	-------

Logic &	N
---------	---

cO F1	XX
-------	----

cO F2	XX
-------	----

RI F1	XXXXX
-------	-------

RI F2	XXXXX
-------	-------

13.2.7.3. Menu *Fire control panel parameters*

Select the menu from the screen:

Fire Panel

The menu contains 5 information screens and 1 menu for the following parameters of the fire control panel:

- Inspection time:
(SSS is the period in seconds - from 0 to 255s; this period is added to the period, necessary for the transition from Fire condition stage I to Fire condition stage II in a line when button  is pressed);
- Interface number:
(NNNN is the number (address) for data exchange via interface - from 0000 to 9999);
- Baud rate:
(BBBBB is the baud rate of exchange via interface (bits in second) - 1200, 2400, 4800 or 9600 bd);
- Modem supported:
(At N=0 a modem is not supported via interface RS232, at N=1 a modem is supported)
- Screen Language
(The current language is English. The fire control panel supports three languages: English, Bulgarian and Russian)

Insp Time	SSSs
-----------	------

Interf N	NNNN
----------	------

BaudRate	BBBBBbd
----------	---------

Modem	N
-------	---

Language	Engl
----------	------

- Menu Telephone Numbers
Select the menu from screen



Telephone Numbers

The menu contains 4 screens for all four telephone numbers that the modem dials if an event occurs: (n is the consecutive number of the telephone number, from 1 to 4)



Phone Number n

Press the  button to display the information screen for a particular telephone number:



Nn tXXXXXX

- ◆ n is the consecutive number of the telephone number;
- ◆ t is the type of dialing – P (pulse dial) or T (tone dial);
- ◆ XXXXXX is the telephone number and you may use symbols like #, *, comma and digits from 0 to 9.

The maximum length of each telephone number is up to 20 characters, including the dial type. If the total length of the telephone number is up to 12 characters it will be displayed in full. If the total length is more than 12 characters the telephone number will be displayed on two screens, the first one containing characters from 1 to 12, the second one containing the characters from 9 to the last one. To switch from screen one to screen two and back, press

button .

13.2.8. Menu *Adjustment*

Select the menu from the screen:



Adjustment

This is the menu for adjustment (see section 14).

13.2.9. Menu *Archive review*

Select the menu from the screen:



ArchivesReview

The menu displays information on the events saved in the energy independent memory.

First, an information screen for the total number of Fire conditions stage II, registered after the initial start up of the fire control panel is displayed; NNNN is the total number of Fire conditions stage II.



FireNumbers NNNN

The following information screens visualize specific information relevant to each event that has been registered by the fire control panel:

- Line N Normal – line number N has restored from Fire condition, Fault condition or Disable mode;
- Line N Fire 1 – line number N has entered Fire condition stage I;
- Line N Fire 2 - line number N has entered Fire condition stage II;
- Line N Disabled – line number N has been disabled;
- Line N Rmvd FD – line number N has entered Fault condition: removed fire detector;
- Line N Interr. – line number N has entered Fault condition: break in a line;
- Line N Short – line number N has entered Fault condition: short circuit in a line;
- Line N Rst test – line number N has entered Test mode;
- Line N Rst test – line number N has exited Test mode;
- Output N Normal – controllable output number N has restored from Fault condition or disabling;
- Output N Disabled – controllable output number N has been disabled;
- Output N Interr – controllable output number N has entered Fault condition: Interrupted controllable output;
- Output N Short – controllable output number N has entered Fault condition: short circuit in controllable output;
- No 220V – the fire control panel has entered Fault condition: interruption in mains supply;

- No 220V Rst – the fire control panel has exited Fault condition: interruption in mains supply;
- Flt: Battery – the fire control panel has entered Fault condition: fault in backup battery supply;
- Flt: Rst Battery – the fire control panel has exited Fault condition: fault in backup battery supply;
- Flt: Uuser –the fire control panel has entered Fault condition: fault in external devices supply;
- Flt: Rst Uuser – the fire control panel has exited Fault condition: fault in external devices supply;
- Flt: Earth – the fire control panel has entered Fault condition: short circuit in ground wire;
- Flt: Rst Earth - the fire control panel has exited Fault condition: short circuit in ground wire
- Flt: Uintrn – the fire control panel has entered Fault condition: fault in internal supply;
- Flt: Rst Uintrn - the fire control panel has exited Fault condition: fault in internal supply;
- Flt: Charger – the fire control panel has entered Fault condition: fault in charger;
- Flt: Rst Charger - the fire control panel has exited Fault condition: fault in charger ”;
- Batt Low – the fire control panel has entered Fault condition: low battery due to interrupted mains supply;
- Reset – initial reset of the fire control panel after start up or upon exit of Adjustment Mode;
- Manual Adjust – the fire control panel has entered Adjustment mode;
- Remote Adjust – the fire control panel has entered Fire Control Panel Parameter or Fire Alarm Line Parameter via interface;
- WatchdogReset – the protection timer of the fire control panel is triggered.

Press and hold the button  to display information screen for event’s date and time, where HH:MM stand for hours and minutes, DD-MM-YY stand for date, month and year.



The screen is visualized when button  is being pressed and hold.

13.3. Information screen *Disabled Controllable Outputs*

Where no disabled controllable outputs are available, the following information screen is displayed:



Where disabled controllable outputs are available, the following information screen is displayed:



The field “12” in screen’s right part contains the numbers of the disabled controllable outputs.

13.4. Menu *Status*

Select the menu from the screen:



The menu contains the following subordinate menus:

- Line status
- Controllable output status

13.4.1. Menu *Line status*

Select the menu from the screen:



Information screens for the status (current state) of the lines are displayed; N is the number of the selected line, Status is its current state.



The following states are feasible:

- Normal – for a line in normal state;
- Fire 1 – for a line in Fire condition stage I which has not entered fault condition afterwards;
- Fire 2 - for a line in Fire condition stage II which has not entered fault condition afterwards;
- Disabled – for a disabled line;
- Rmvd FD – for a line with removed fire detector;

- Intrr – for an interrupted line;
- Short – for a line in short circuit.

13.4.2. Menu *Controllable output status*

Select the menu from the screen:



Information screens for the status (current state) of the controllable outputs are displayed; N is the number of the selected controllable output, Status is its current state.



The following states are feasible:

- Normal – for a controllable output in normal state;
- Disabled. – for a disabled controllable output;
- Intrr – for an interrupted controllable output;
- Short – for a controllable output in short circuit.

14. Set Up Mode

14.1. Description

Set Up Mode is used for setting configuration parameters of a fire control panel. Access is provided through the screen of Information and Control Mode, menu System functions, submenu Set Up (see section 13 – Information and Control Mode). When the fire control panel enters Set Up Mode, it exits all other modes or conditions. Upon exit the detected configuration of additional modules is saved in the energy independent memory and the unit is reset.

When the fire control panel operates in Set Up Mode it does not serve fire alarm lines, controllable outputs and the other periphery devices (all lines and outputs are switched off); the fire control panel is controlled via the keypad for mode operation.

In this state the indicator  (Fault condition) illuminates in continuous yellow light, and the local sounder is switched off.

The same principles apply to screen organization and keypad operation in Information and Control Mode (see section 13.1).

14.2. Menus

The menu contains the following subordinate menus and functions:

- Password
- Line parameters
- Fire control panel parameters
- Adjustment of controllable outputs
- Adjustment of relay outputs
- Default parameters
- Clear archive
- Enter new password.

14.2.1. Function *Password*

Set Up Mode is of Access level 3A, wherefore only the function Password is accessible at initial access to Set Up menu:



Upon activation the screen displays:

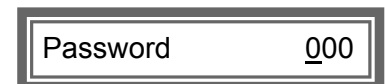

and the cursor is positioned over the first digit of 000 (password). When the desired password is already set, press  and, if the value is correctly entered (matches with the preset password), the fire control panel enters Set Up Mode. Access to level 3A is then provided and the subordinate menus and functions, included in menu Set Up, are now accessible.



14.2.2. Menu *Line parameters*

Select the menu from the screen:



It includes the same screens as the analogical submenu of the menu *Parameters review* (see section 13.2.7.2) with one difference only: when button  is pressed, a screen for parameter change appears and the parameters can be modified within specified limits.

The modification of parameter Logical AND has the following special features:



- A line can not be set in Logical AND dependency by itself – button  is not active in this case;
- A line can not be set in Logical AND dependency by a line that has already been set in such dependency by a third line - button  is not active in this case either;
- Where a line is set in Logical AND dependency by another line, the second line is automatically set in the same dependency – in the parameter Logical AND of the second line the number of the first line is saved;
- Where a line exits the Logical AND dependency, the second line exits the dependency too – in the parameter of the second line is saved “0”;
- The Logical AND dependency can cover only two fire alarm lines – if, before the modification of the parameter Logical AND, it contained a number of a third line, the third line automatically exits the dependency (in the third line’s parameter Logical AND is saved “0”)

14.2.3. Menu *Fire control panel parameters*

Select the menu from the screen:



It includes the same screens as the analogical submenu of the menu *Parameters review* (see section 13.2.7.3) with the following differences:

- When button  is pressed, a screen for parameter change appears and the parameters can be modified within specified limits
- Screens for telephone number entry: press button  to move the cursor one position to the right. Where the telephone number contains more than 12 characters moving the cursor from the 12th to the 13th character will result in moving the information on the display 8 positions to the left; i.e. characters from 9 to the last one will be displayed. If you press button , when the cursor is positioned over the first empty position after the telephone number or is over the 20th character, the beginning of the telephone number will be displayed and the cursor will be positioned over the first character (the dial mode).



14.2.4. Function *Adjustment of controllable outputs*

Activate the function from the screen

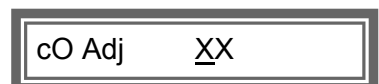

When the function is active the following command screen appears:



where X can adopt 0 (the controllable output will not operate) or 1 (the controllable output will operate). The left position corresponds to Controllable output 1. Press button  to activate the selected controllable outputs and keep them active by holding the button down. Deactivate the function by pressing the button .



14.2.5. Function *Adjustment of relay outputs*

Activate the function from the screen:

RI Adj

When the function is active the following command screen appears:

RI Adj XXXXX

where X can adopt 0 (the relay output will not operate) or 1 (the relay output will operate). The left position corresponds to Relay output 1. Press button  to activate the selected relay outputs and keep them active by holding the button down. Deactivate the function by pressing the button .

14.2.6. Function *Default parameters*

Select the function from the screen:

Default

Upon activation of the function the following default parameters are saved in the energy independent memory of the fire control panel

- Line parameters:
 - ◆ Number of reviews - 2;
 - ◆ Check up for a removed fire detector - activated;
 - ◆ Period for transition from Fire condition stage I to Fire condition stage II - 120s;
 - ◆ Current threshold above which Fire condition stage I in a line is detected - 12mA;
 - ◆ Current threshold above which Fire condition stage II in a line is detected - 40mA;
 - ◆ Current threshold above which Short circuit in a line is detected - 70mA;
 - ◆ Current threshold below which Break in a line is detected - 3mA;
 - ◆ Logical AND of a line – not set;
 - ◆ Controllable outputs upon Fire condition stage I in a line – will not operate;
 - ◆ Controllable outputs upon Fire condition stage II in a line – will not operate;
 - ◆ Relay outputs upon Fire condition stage I in a line – will not operate;
 - ◆ Relay outputs upon Fire condition stage II in a line – will not operate;
- Fire control panel parameters:
 - ◆ Inspection time - 120s;
 - ◆ Interface number - 1234;
 - ◆ Baud rate - 9600bd;
 - ◆ Modem – no modem;
 - ◆ Language - English
- Lines in test condition – no such lines;
- Disabled lines – no such lines;
- Disabled controllable outputs – no such outputs.

14.2.7. Function *Clear archive*

Select the function from the screen:

ClearArchives

Use it to delete events information saved in the energy independent memory of the fire control panel.

The activated function displays the following screen:

ClearArchives >>

The counter of fire conditions is not deleted here. It can be zeroed in a special mode only (Access level 4).

14.2.8. Function *Enter new password*
 Activate the function from the screen:

 A rectangular box with a double border containing the text "New Password".

The activated function displays the following screen:

 A rectangular box with a double border containing the text "New Password" followed by "000" with a cursor under the first zero.

and the cursor is positioned over the first digit of 000 (password). The function enables the user to enter a new access password for Set Up Mode.

15. Remote Control Mode

15.1. Description

The fire control panel enters Remote Control Mode when an external control unit of higher level (computer from a centralized dispatcher control point or other) sets the panel's configuration parameters via serial interface. In this case the fire control panel exits all other modes/conditions. When the fire control panel operates in Remote Control Mode, it does not serve fire alarm lines, controllable outputs either other periphery devices (all lines and outputs are switched off); it is under the control of the external unit. When the fire control panel exits the mode, initial reset is being done.

15.2. Indications

15.2.1. LED and sound indication

In this mode indicator  (Fault condition) illuminates in continuous yellow light, the local sounder is switched off.

15.2.2. Text messages

The following screen is displayed:

 A rectangular box with a double border containing the text "Remote Control".

15.3. Using the keypad

No buttons are active in this mode.

16. Saving the parameters

All set parameters or modes of operation are being saved in the energy independent memory and upon interruption of mains or backup battery supply they remain unchanged. When the fire control panel is powered again, it operates according the preset parameters and modes. The default parameters and modes are factory setup (see section 14.2.6). User password is set to 000.

No telephone numbers to be dialed by the modem are entered.

17. Labour protection requirements

The installation and maintenance staff shall be well grounded in equipment's mechanism and operation, as well as in common technical safety regulations.

Connection to unearthed or to indirectly earthing mains supply is prohibited.

Troubleshoots are to be cleared after disconnecting the feeding cable from the mains supply.

The control panel is designed for installing in premises with a normal fire hazard, as per the Fire Precaution Technical Regulations in Building Construction.

18. Installation and arrangements

When fire detectors and periphery devices are integrated in the system, avoid arranging wires in closed loops; it will reduce the control panel's resistance to electro magnetic interferences

18.1. To mount the fire control panel

- unpack the device;
- put the dowels on the determined places;
- fasten the control panel to the dowels through the three holes provided on the chassis.

18.2. Periphery devices assembly

All connections are to be made by means of terminals, mounted on the printed circuit boards (Appendixes 4, 5 and 6). Be advised, that the consumption of the voltage powering the external devices (terminal "+ 24V" on the basic module) shall not exceed 1.3A in heavy-duty mode. Here is included the consumption of the controllable outputs powered by the same voltage.

18.2.1. Mounting periphery devices to controllable outputs

Terminals "+Out1", "-Out1", "+Out2", "-Out2" of the Basic module are used – controllable, potential outputs, responding upon Fire condition stage I or Fire condition stage II (depending on the pre-programming of the relation fire alarm line – controllable outputs).

Use the special connection diagram for the executive device provided in Appendix 7c.

End of line resistors 5k6 are connected directly to the terminals of the unused controllable outputs.

18.2.2. Mounting periphery devices to relay outputs

The following terminals are used:

- Terminal "+24V" of the Basic module – positive lead of the stabilized direct current supplying the external devices (light and sound signaling devices, executing devices and others);

- Terminal "GND" of the Basic module – chassis ground (negative lead of the stabilized direct current supplying the external devices);

- Terminals "Rel1/C", "Rel1/NO", "Rel1/NC", "Rel2/C", "Rel2/NO" и "Rel2/NC" of the Basic module, "Rel3", "Rel4", and "Rel5" of Modules 5101 or 5102 – potential free relay contacts, responding at Fire condition stage I or Fire condition stage II (in compliance with the pre-programming of the relation fire alarm line – relay outputs). Contact's type of terminals "Rel3", "Rel4", and "Rel5" is set by means of "NC-NO" changeover of Module 5101 or 5102 (Appendixes 5 and 6);

- Terminals "REL Fault/C", "REL Fault/NO" and "REL Fault/NC" of the Basic module – potential free relay contacts. When no fault condition is detected terminals "REL Fault/C" and "REL Fault/NO" are connected; upon detection of fault condition terminals "REL Fault/C" and "REL Fault/NC" are connected.

The executive device shall be connected according to Appendix 7 d. Output type for the relay outputs, situated on Module 5101 or 5102 is selected by means of jumpers – normally open (NO) or normally closed (NC).

Unused relay outputs remain unoccupied.

18.3. Connecting interface units

To connect interface units you need a fire control panel with basic module that supports RS232 or RS485 serial interface (delivered upon customer's order). The interface units are connected to one of the two interfaces, by means of 9 - lead coupling, available on the basic module. Signals distribution is shown in Table 3.

Table 3

Coupling's lead	Signal of RS232 Interface	Signal of RS485 Interface
2	RXD (input data)	Inverting input/output
3	TXD (output data)	Non inverting input/output
4	DTR	
5	GND (chassis ground)	

The fire control panel provides power supply to an external modem, if the feature has been included in the order. The power supply is tapped on a two-pole terminal on the Basic module.

18.4. Connecting fire detectors

Fire detectors are connected to the fire control panel by means of two-wire insulated line of total resistance up to 100Ω. Connection is made to the terminal of the corresponding modules (Appendixes 4, 5 and 6) – "+Lin1" "-Lin1", "+Lin2" и "-Lin2" of the Basic Module, "+Lin3" "-Lin3", "+Lin4" "-Lin4", "+Lin5" and "-Lin5" of Module 5101 or 5102; "+Lin6" "-Lin6", "+Lin7" "-Lin7", "+Lin8" and "-Lin8" of Module 5102; observing the indicated polarity.

Automatic fire detectors of series FD8000 and FD3000 or compatible can be used (Appendix 7a). To enable detection of Fault condition *Removed fire detector* diodes shall be mounted – for example 1N5819, to the indicated in Appendix 7a direction. To set up a fire alarm line with group addressing of

manual call points and automatic fire detectors you can use FD3050 Manual Call Point or compatible (Appendix 7b).

Up to 32 fire detectors can be integrated in one fire alarm line regardless of their type.
End of line resistors 3k9 are connected directly to the terminals of unused fire alarm lines.

18.5. Connection to power supply

Take out the fuse from the terminal with mains fuse (Appendix 2).

Connect a feeding cable to the terminal with mains fuse, observing the following positions (Appendix 2):

- P – power wire “Phase”;
- N – power wire “Null”;
- \perp - safety ground wire.

The cable shall be double insulated and of 0,5mm² section for the power supply wires, and of 1,5mm² section for the safety ground wire.

The other end of the feeding cable is connected to the mains power supply by means of junction box.

The mains power supply of the fire control panel shall be in a separate loop.

19. Fire control panel start up

Make sure that the connection to mains power supply is properly made.

Make sure that the periphery devices are correctly connected.

Place the fuse in the terminal with mains fuse, the display illuminates and appears the text:

Syst Operation

Connect the feeding cable and the backup batteries; the batteries shall be in a series connection.

Connect the red wire to the positive backup battery pole, and the blue wire - to the negative pole.

The overall voltage of both batteries shall not exceed 17V, otherwise the fire control panel indicates *Fault condition in backup battery supply*.

Enter Set Up Mode and set the common parameters and line parameters. When the fire control panel exits Set Up Mode, it proceeds to System operation and enters Duty Mode – the unit is ready to provide site protection.

20. How to add, remove or replace an additional module

FS5100 fire control panel is able to operate with one additional module of 5101 or 5102 type.

To add an additional module, follow the instructions:

- Open the fire control panel and cut off the power supply by taking the fuse out of the terminal with mains fuse (Appendix 2) and disconnecting the feeding cables of the backup batteries;
- Drive the available M3 screw into the hole on the panel's bottom, provided for additional modules. (Appendix 3);
- Connect the available band cable to the connector of the module and to the connector of the basic module (Appendix 3);
- Fix the additional module in a way that the M3 screw enters the provided hole expansion and the restricting strap on the panel's bottom is in opposite direction of the module's slot (Appendix 3);
- Slide the additional module down until rest (Appendix 3);
- Screw M3 until rest;
- Connect the fire alarm lines or the executive devices to the newly added module (Appendixes 5 and 6);
- Restore the power supply of the fire control panel by placing the fuse back in the terminal with mains fuse (Appendix 2), connect the feeding cables to the backup batteries and close the fire control panel;
- The fire control panel proceeds to System operation and enters Fault condition: Circuit boards conflict;
- Enter Set Up Mode and if necessary, re-configure the fire control panel;
- When the fire control panel exits Set Up Mode, it proceeds again to System operation and enters Duty Mode – the unit is ready to provide site protection.

To remove an additional module, follow the instructions:

- Open the fire control panel and cutt off the power supply by taking the fuse out of the terminal with mains fuse (Appendix 2) and disconnecting the feeding cables of the backup batteries;
- Disconnect the fire alarm lines or executive devices from the module you want to remove;
- Unscrew the M3 screw until the module is loose (Appendix 3);
- Slide the additional module upwards so that the M3 screw enters the provided hole expansion (Appendix 3);
- Take the module out;
- Disconnect the module's band cable from the connector of the basic module (Appendix 3);
- Unscrew and remove M3 (Appendix 3);
- Restore the power supply of the fire control panel by placing the fuse back in the terminal with mains fuse (Appendix 2), connect the feeding cables to the backup batteries and close the fire control panel;
- The fire control panel proceeds to System operation and enters Fault condition: Circuit boards conflict;
- Enter Set Up Mode and if necessary, re-configure the fire control panel;
- When the fire control panel exits Set Up Mode, it proceeds again to System operation and enters Duty Mode – the unit is ready to provide site protection.

To replace an additional module, follow the instructions:

- Open the fire control panel and cutt off the power supply by taking the fuse out of the terminal with mains fuse (Appendix 2) and disconnecting the feeding cables of the backup batteries;
- Disconnect the fire alarm lines or executive devices from the module you want to replace;
- Unscrew the M3 screw until the module is loose (Appendix 3);
- Slide the additional module upwards so that the M3 screw enters the provided hole expansion (Appendix 3);
- Take the additional module out;
- Disconnect the module's band cable from the connector and connect it to the connector of the new module (Appendix 3);
- Place the new additional module in a way that M3 enters the provided hole expansion and the restricting strap on the panel's bottom is in opposite direction of the module's slot (Appendix 3);
- Slide the new additional module down until rest (Appendix 3);
- Screw M3 until rest;
- Connect the fire alarm lines or executive devices to the newly added module (Appendixes 5 and 6);
- Restore the power supply of the fire control panel by placing the fuse back in the terminal with mains fuse (Appendix 2), connect the feeding cables to the backup batteries and close the fire control panel;
- The fire control panel proceeds to System operation and enters
 - ◆ Fault condition: Circuit boards conflict – if the new module is of different type;
 - ◆ Duty Mode – if the new module is of the same type;
- Enter Set Up Mode, if the new module is of a different type or to re-configure the fire control panel. When the fire control pane exits Set Up Mode, it proceeds again to System operation and enters Duty Mode;
- The unit is ready to provide site protection.

21. Troubleshooting

Possible problems and methods of troubleshooting are described in Table 4.

Table 4

















Trouble	Indication	Troubleshooting
System error	Indicators  and  illuminate in steady yellow light; the local sounder releases continuous signal; the message <i>Syst. Error</i> is displayed;	The trouble shall be fixed in Service department
Circuit boards conflict	Indicator  flashes in yellow light, indicator  illuminates in continuous yellow light; the message <i>Boards Conflict</i> appears on the screen	Enter Set Up Mode. Exit the mode and if the problem persists, it shall be fixed in Service department
Low backup batteries due to interrupted mains power supply	The local sounder releases discontinuous signal (1s sound, 3s pause); the message <i>Batt Low</i> appears on the screen; the backlight of the display is off	Restore the mains power supply or replace the backup batteries
Fault in a line	Indicator  flashes in yellow light; the local sounder releases discontinuous signal; the message <i>Flt: Ln</i> appears on the screen	<ul style="list-style-type: none"> - Eliminate the fault (short circuit, interrupted power supply or removed fire detector); - In Fault condition: Removed FD check for short circuit in a component to a ground wire (see <i>Fault condition: Short circuit to ground wire</i>)
Fault in a controllable output	Indicators  and  ; illuminate in steady yellow light; the local sounder releases discontinuous signal; the message <i>Flt: cO</i> appears on the display	<ul style="list-style-type: none"> - Eliminate the fault (short circuit or interruption) in the fire alarm line of the controllable output or executive device; - Upon <i>Fault condition: Interruption</i> check for short circuit in component of the controllable output to ground wire (see <i>Fault condition: Short circuit to ground wire</i>)
Fault in mains power supply	Indicators  and  illuminate in steady yellow light; the local sounder releases discontinuous signal; the message <i>No 220V</i> appears on the screen	<ul style="list-style-type: none"> - Restore the mains power supply; - Substitute Fuse 1 – 4A with a mains fuse
Fault in backup battery supply	Indicators  and  illuminate in steady yellow light, the local sounder releases discontinuous signal; the message <i>Flt: Battery</i> appears on the display	<ul style="list-style-type: none"> - Place or replace the backup batteries; - Replace the burnt fuse Fs 2 – 4A
Fault in power supply to external devices	Indicator  flashes in yellow light; the local sounder releases discontinuous signal; the message <i>Flt: User</i> appears on the display	Eliminate overload of power supply to external devices

Table 4 - Continue

Trouble	Indication	Troubleshooting
Short circuit to ground wire	Indicator  flashes in yellow light; the local sounder releases discontinuous signal; the message <i>Flt: Earth</i> appears on the display	Eliminate the short circuit
Fault in internal power supply	Indicator  flashes in yellow light; the local sounder releases discontinuous signal; the message <i>Flt: Uintrn</i> appears on the display	The fault shall be fixed in Service department
Fault in charger	Indicators  and  ; illuminate in steady yellow light; the local sounder releases discontinuous signal; the message <i>Flt: Charger</i> appears on the screen	The fault shall be fixed in Service department

22. Conditions of operation, storage and transportation

22.1. Operation and storage

The fire control panel shall operate and be kept in closed premises, under the following conditions:

22.1.1. Temperature

- storage - from +5 to +35°C
- transportation - from -10 to +50°C
- operation - from -5°C to +40°C

22.1.2. Relative humidity

- storage - up to 80%
- operation - up to 93%

22.2. Transportation

The fire control panel shall be transported by vehicles, in factory packing, in the above stated environmental conditions and at sinusoidal vibrations with acceleration amplitude not more than 4,9m/s² in frequency range 10 to 150Hz.

23. Warranty

The producer guarantees compliance of the unit with EN 54-2:1997 / AC:1997 and EN 54-4:1997 / AC:1999. The warrant period is 18 months from the date of the purchase, providing that

- The conditions of storage and transportation have been observed;
- The startup has been done by authorized personnel only
- The requirements for operation stated herein have been observed.

UniPOS wishes you a successful work!

24. Appendixes

Appendix 1

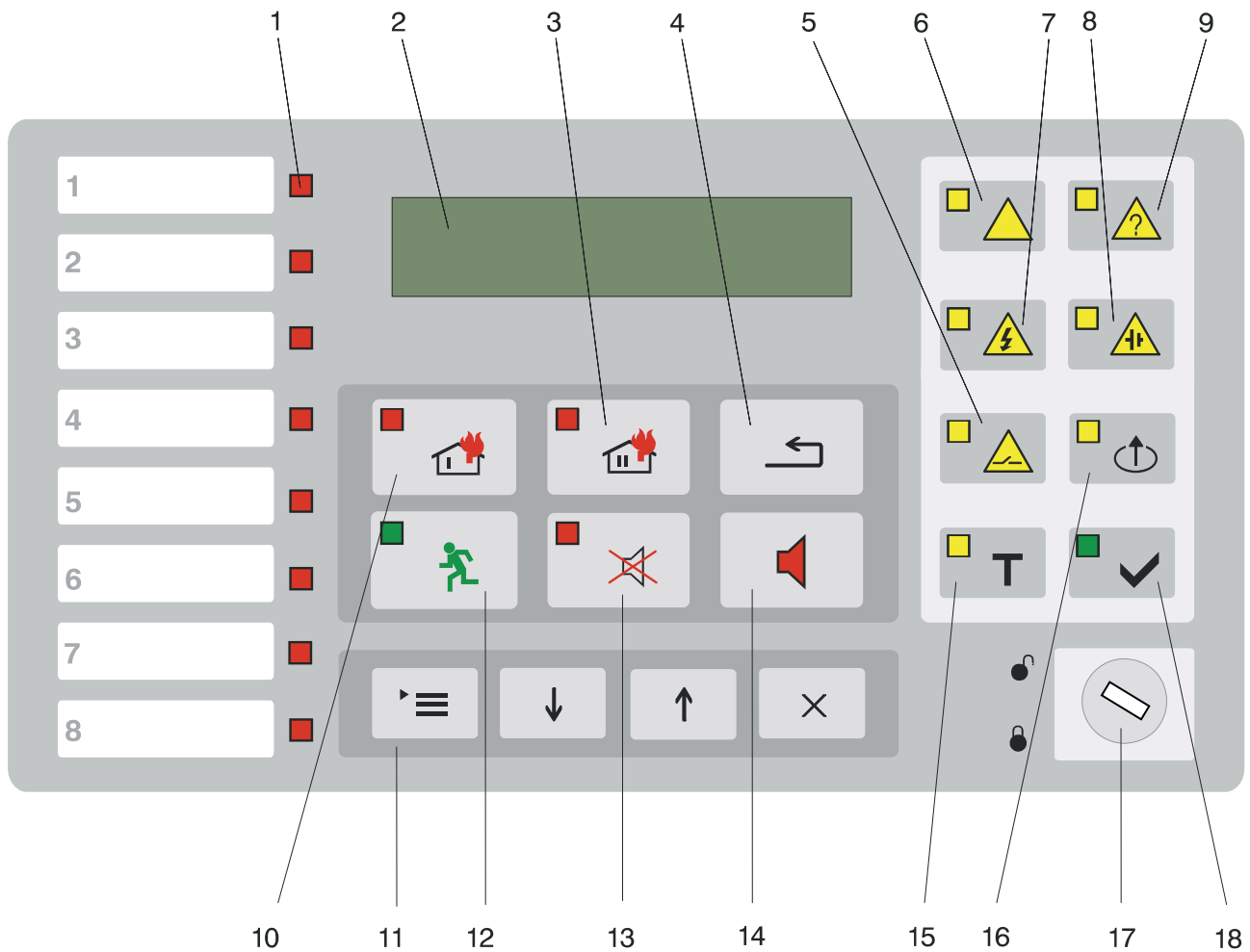

- 1 Separate indicators for fire condition
- 2 LCD display (1x16)
- 3 Common indicator Fire condition stage II
- 4 Fire alarm line reset
- 5 Indicator Out of order/disabled controllable output
- 6 Indicator System error
- 7 Indicator Fault in mains power supply
- 8 Indicator Fault in backup batteries
- 9 Common indicator for fault condition
- 10 Common indicator Fire condition stage I
- 11 Buttons for menu
- 12 Button with indicator Inspection
- 13 Button with indicator Stop alarm
- 14 Button Start alarm
- 15 Indicator Test
- 16 Indicator Disabled component
- 17 Key for Access level 2
- 18 Indicator Power supply

Front panel of FS5100

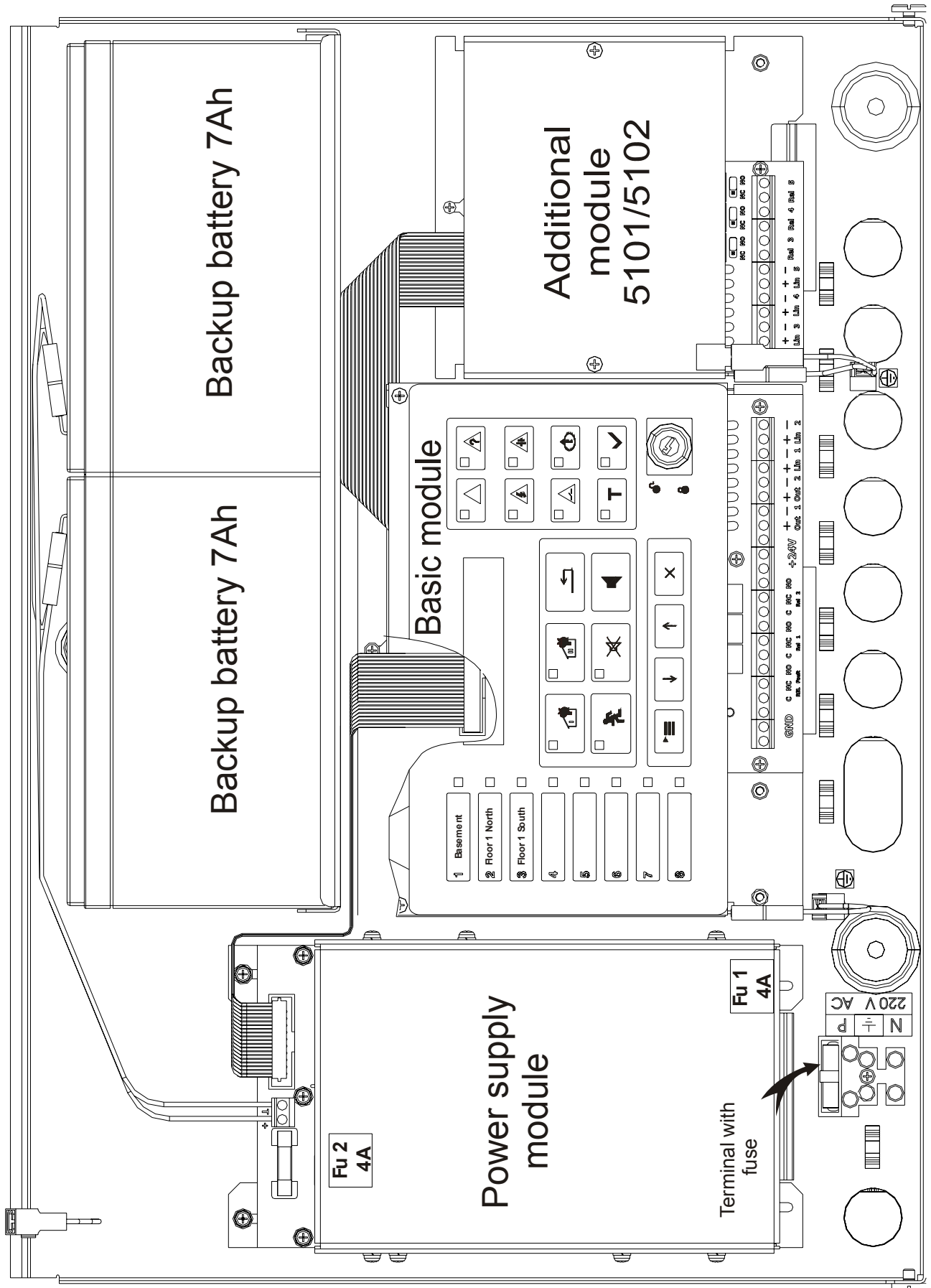

Assembly diagram

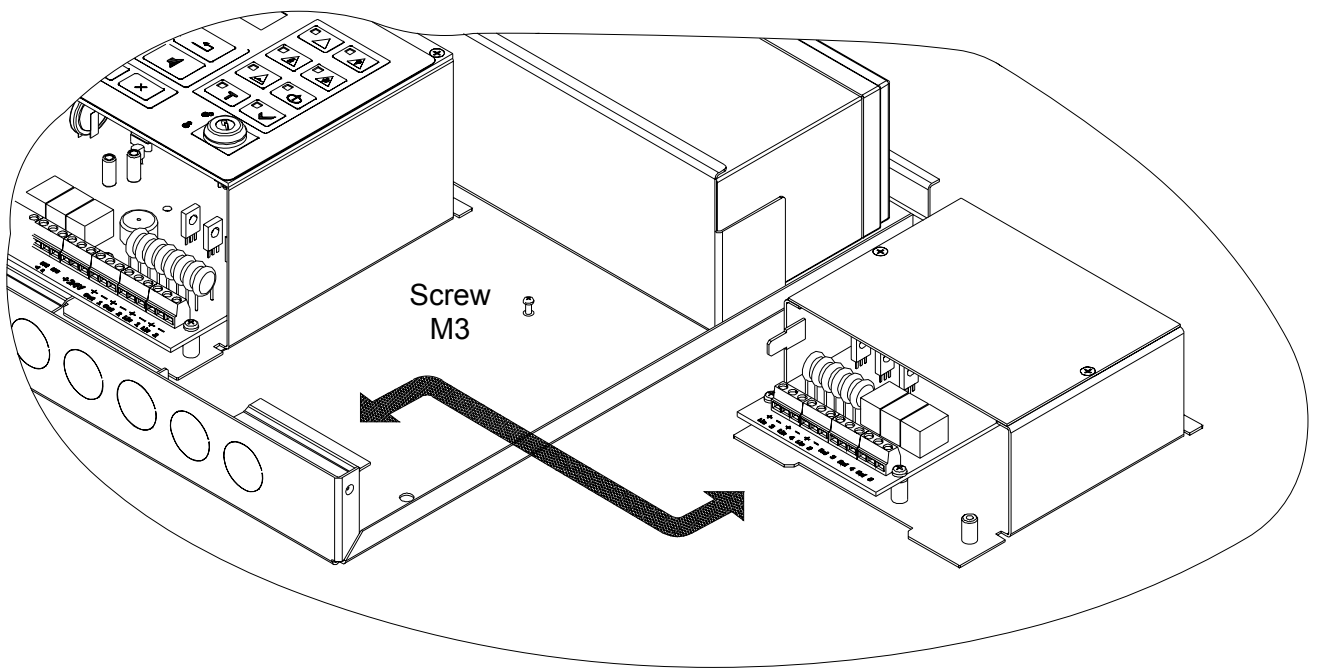
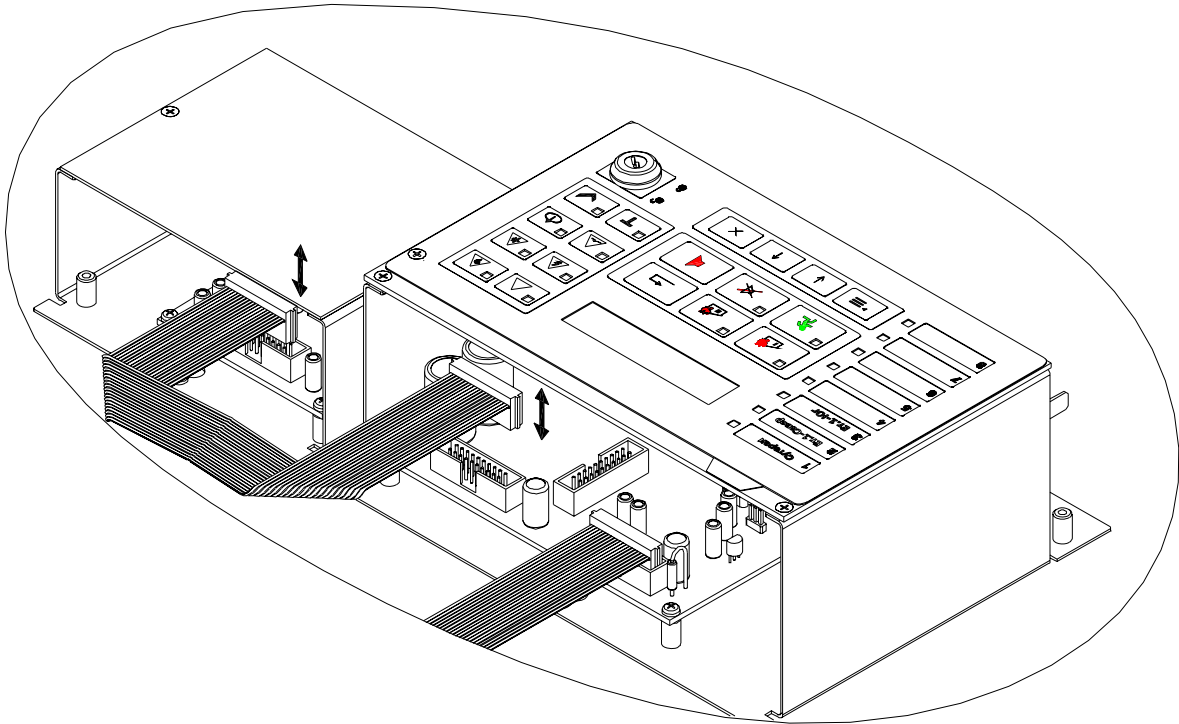

Connection of additional module

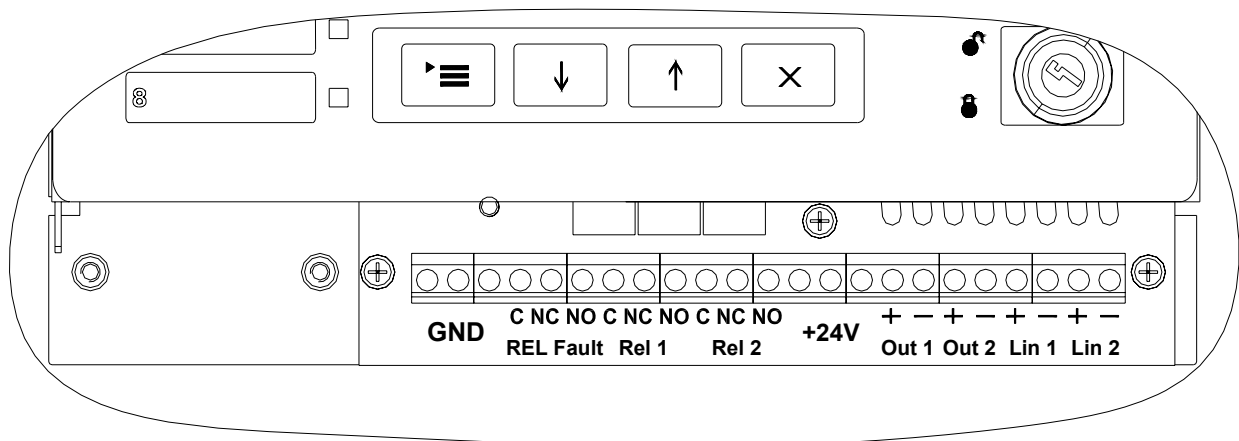
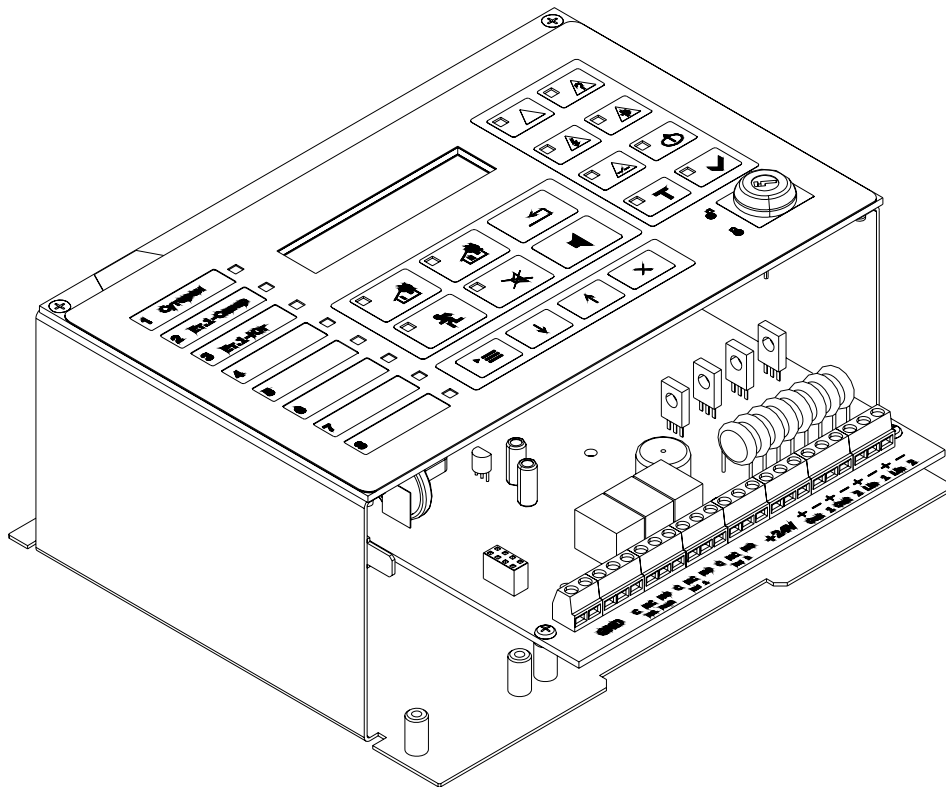

- Lin x – leads of fire alarm line № x
- “+” – positive lead
- “-“ – negative lead
- Out x – leads of controllable output № x
- “+” - positive lead
- “-“ – negative lead
- REL Fault – relay outputs for fault condition
- C – common contact
- NO – normally open contact
- NC – normally closed contact
- Rel x – relay outputs for fire condition
- C – common contact of relay output
- NO - normally open contact
- NC - normally closed contact
- +24V – positive lead of the power supply to external devices
- GND – negative lead of power supply to external devices (chassis earth);

Basic Module
 (2 fire alarm lines, 2 controllable outputs,
 2 relay outputs for fire condition and 1 relay output for fault condition)

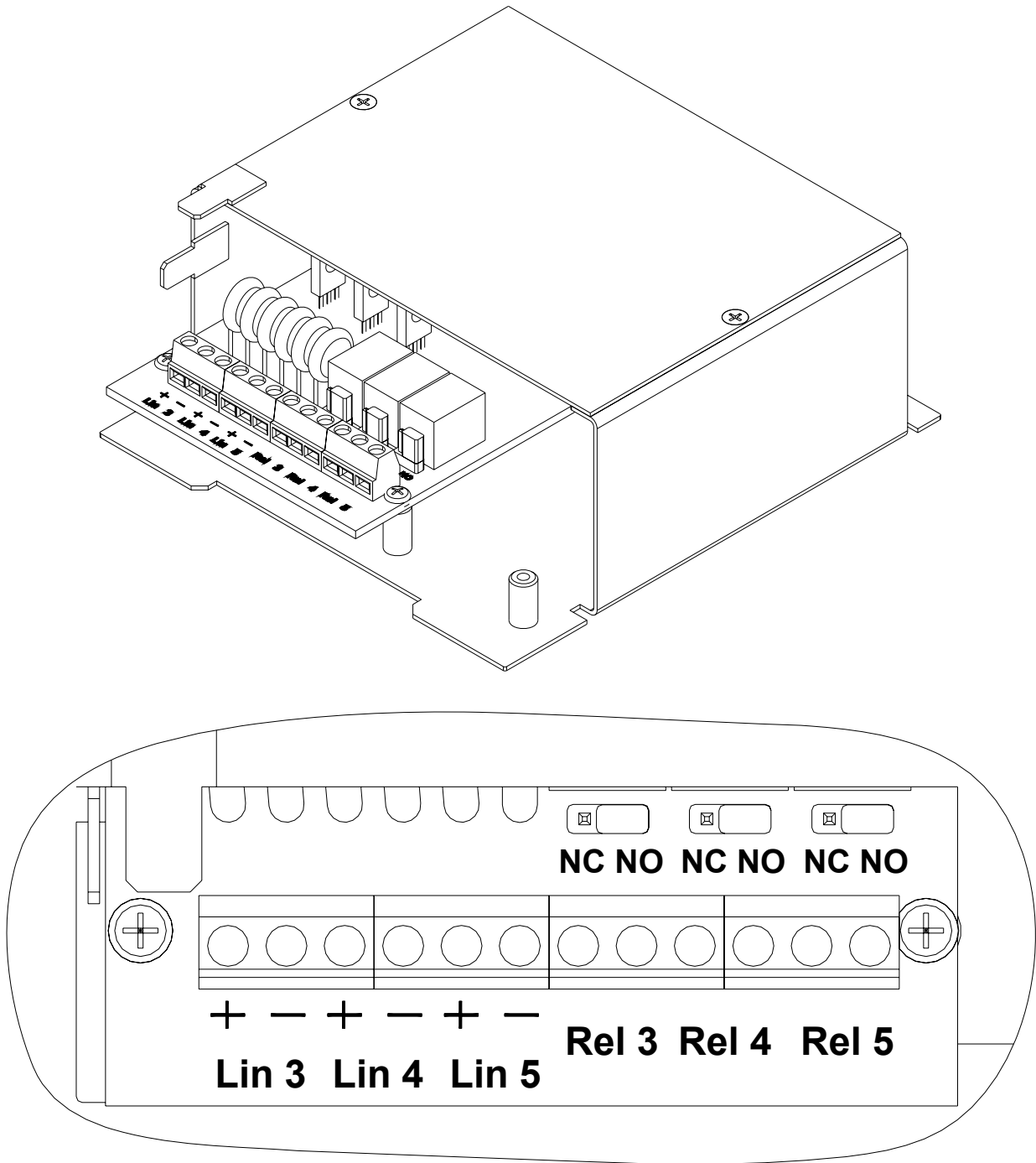

- Lin x – leads of fire alarm line № x
- “+” – positive lead
- “-” – negative lead
- Rel x – relay outputs for fire condition
- NC / NO – changeover for the type of the relay contact
- NO – normally open,
- NC – normally closed

Module 5101
 (3 fire alarm lines and 3 relay outputs for fire condition)

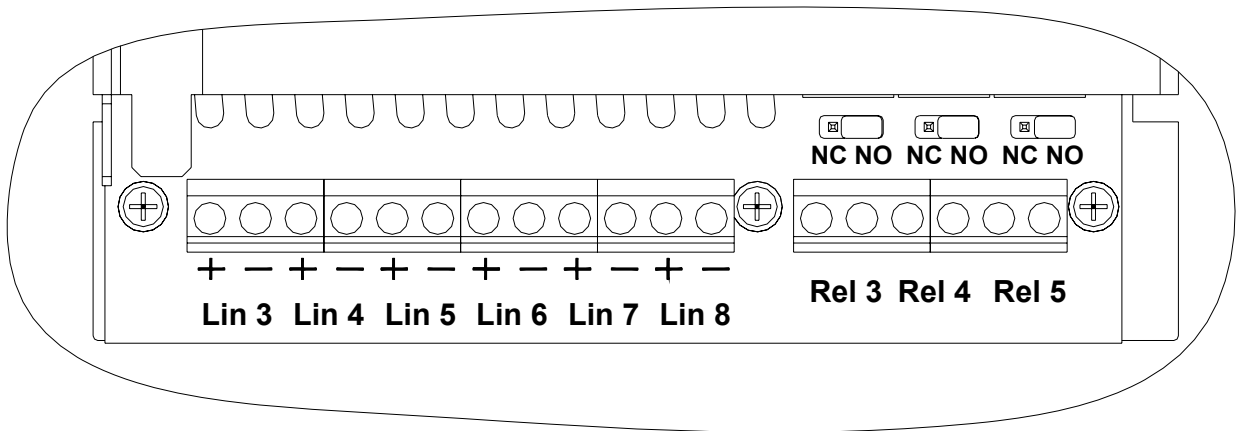
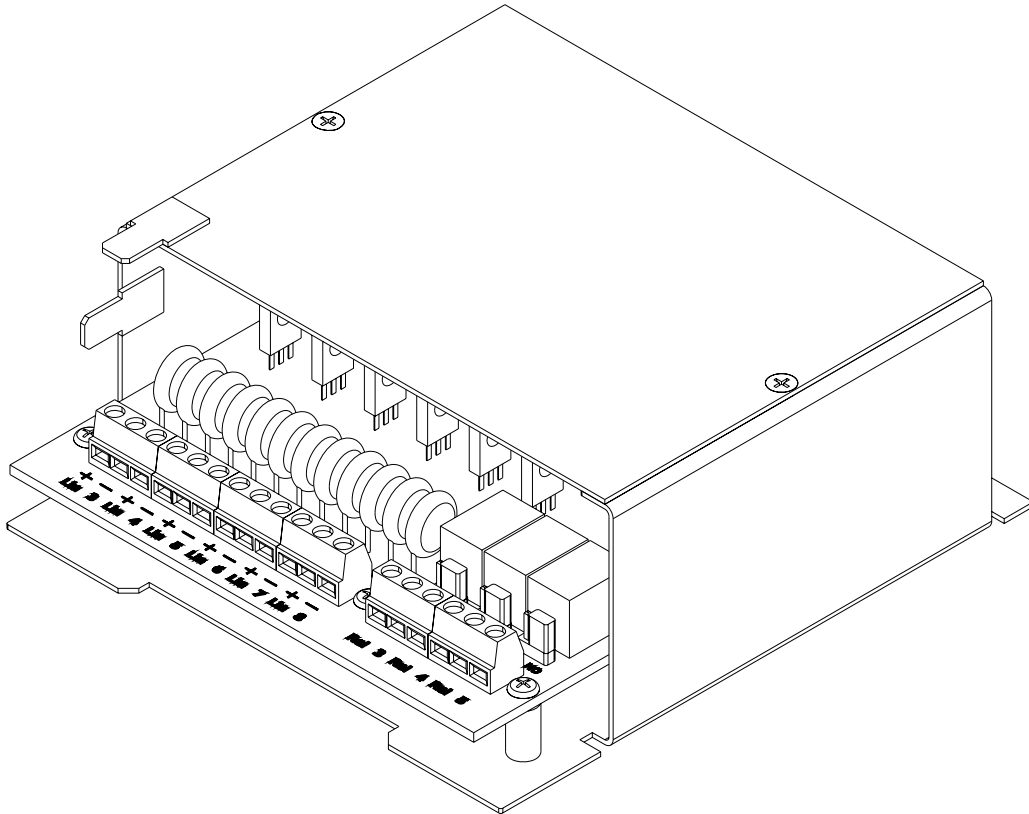

Lin x – leads of fire alarm line № x
 “+” – positive lead
 “-” – negative lead
 Rel x – relay outputs for fire condition
 NC / NO – changeover for the type of the relay contact
 NO – normally open,
 NC – normally closed

Module 5102
 (6 fire alarm lines and 3 relay outputs for fire condition)

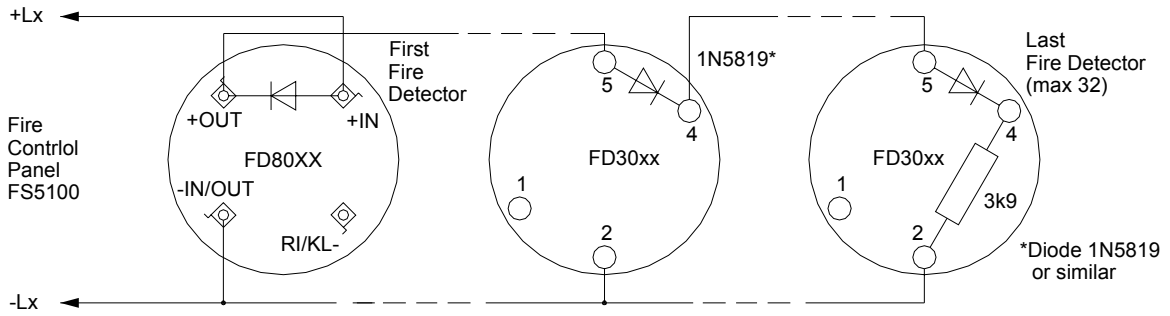

a) fire alarm line with automatic fire detectors type FD8000 or FD3000

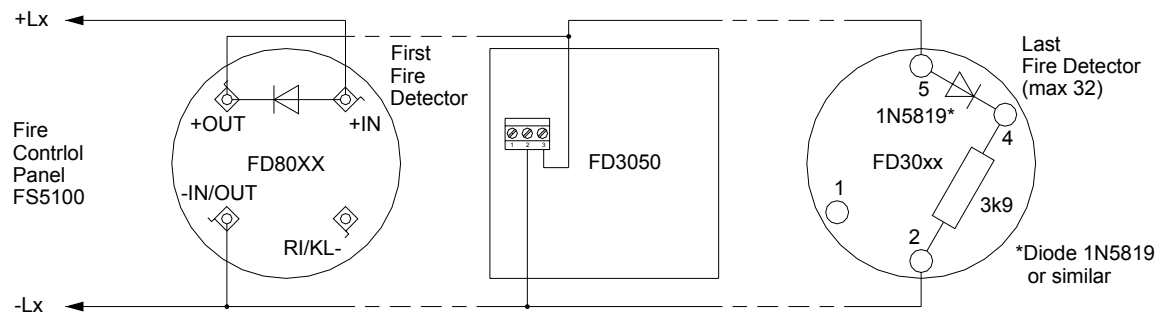

b) fire alarm line with group addressing of automatic fire detectors type FD8000 or FD3000 and manual call points type FD3050

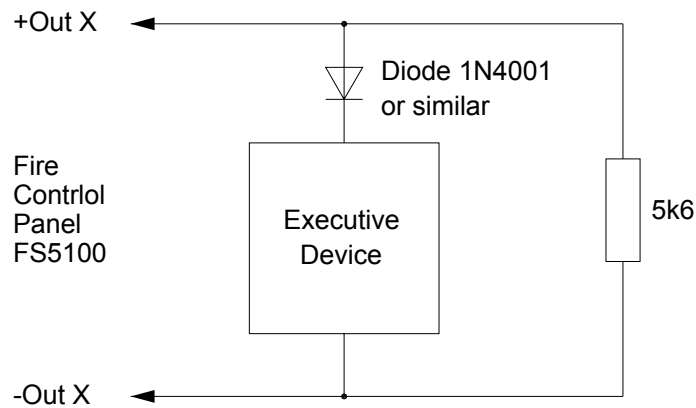

c) connection of executive device to a controllable output

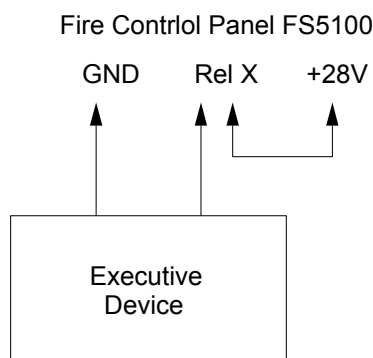

d) connection of executive device to a relay output

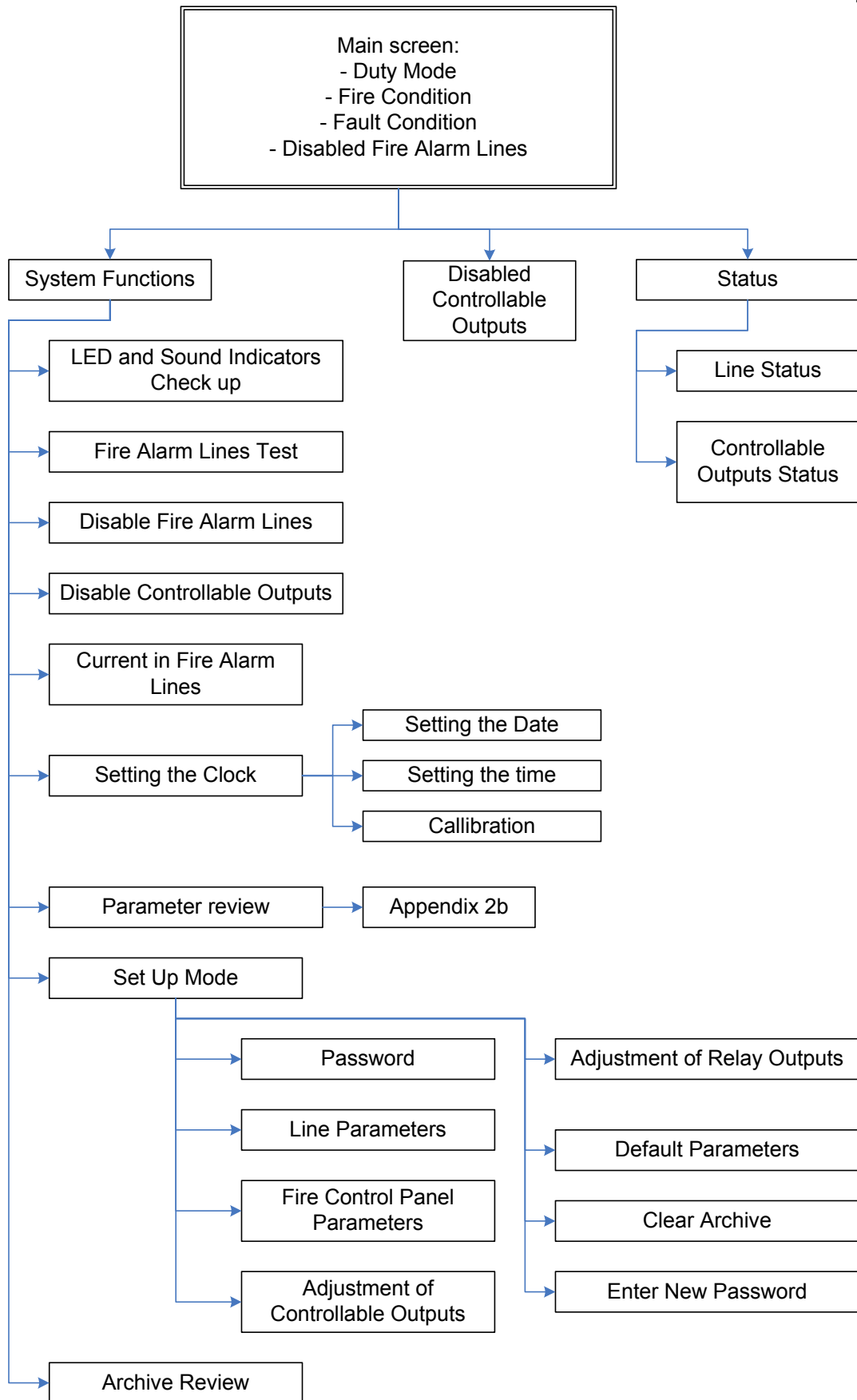

a) Main menu

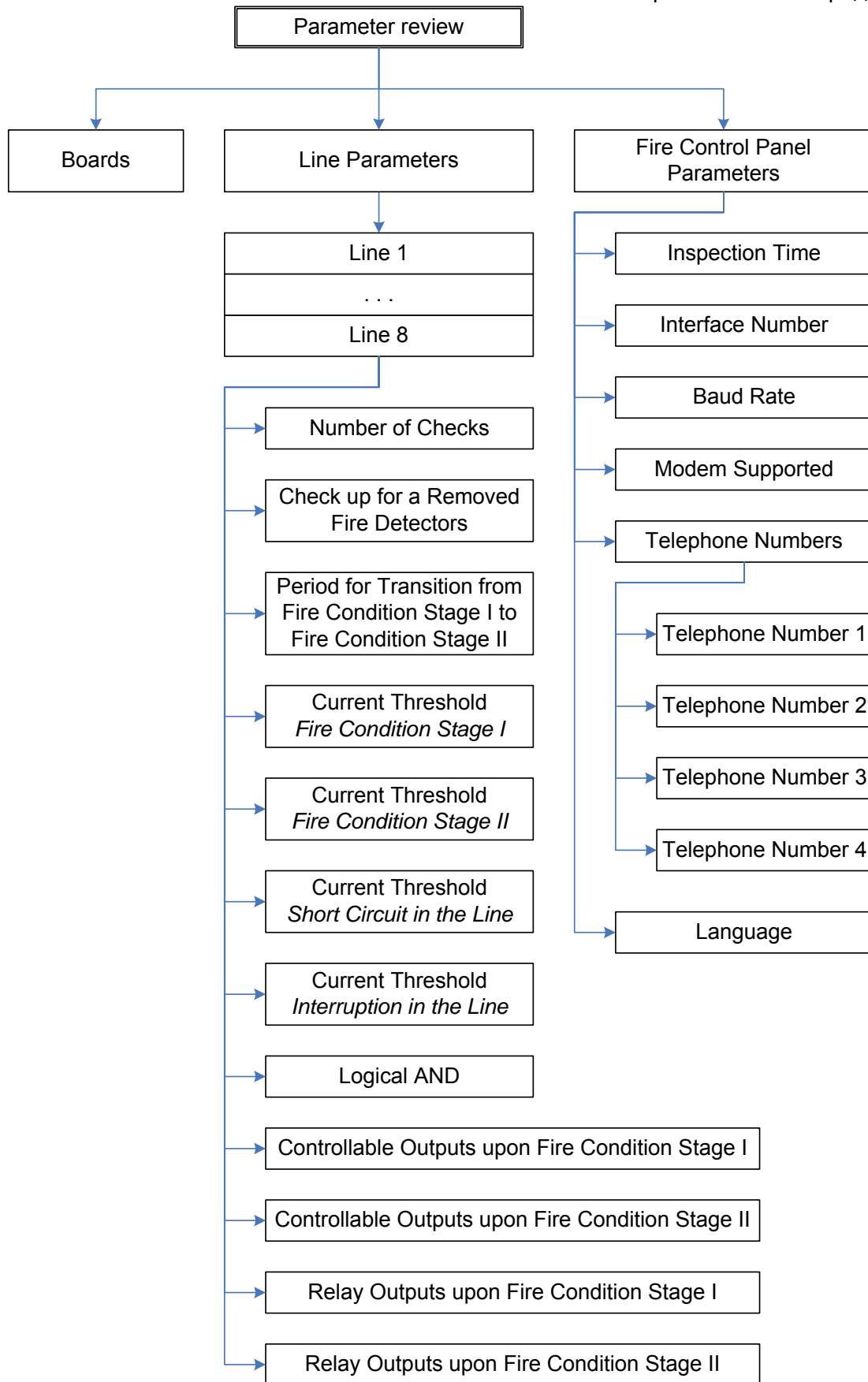

б) Menu *Parameters Review*

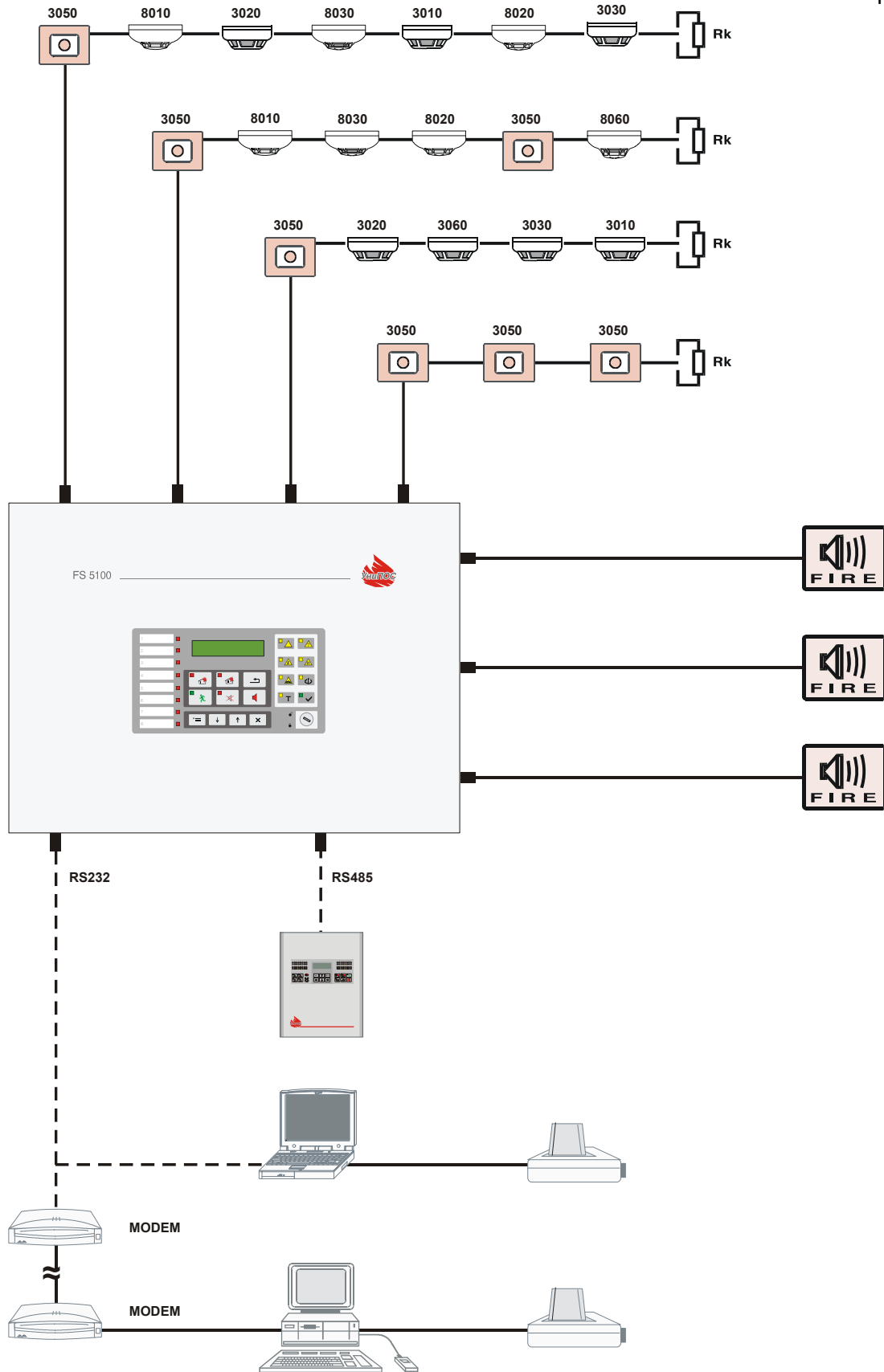

Diagram of fire alarm installation based on Fire control panel FS5100