

LINEA 6A IP Hi-PoE MK II

LINEA 6A IP Hi-PoE MK II PLUS

Hi-PoE MK II CAMERA HOUSING
Patent Pending

Hi Power over Ethernet Camera Housing,

Hi-PoE MKII for IP Camera or Hi-PoE MKII PLUS for IP PoE Camera

Punch Down Terminal fast connection

Weatherproof

Heater with thermostat, Blower kit,

Wall bracket BW6H6



Hi-PoE MKII Housing

Video data and feeding power are brought in through one single CAT5 cable.

New Punch Down Terminal fast connection.

PLUG & PLAY Solution

The Ethernet sealed RJ45 receptacle on the back cap (patent pending) assures a quick, safe and reliable on site plug&play connection.

FULL OPTIONAL

Heater and blower kit are factory installed, cabled and ready to use.

SUITABLE FOR OUTDOOR AND INDOOR

Weatherproof rated, the integrated sunshield and the large window guarantee clear images and no vignetting



tekno system®

Italian design for CCTV since 1979

Tekno System S.p.A.

Via Rostoncello, 1 - 36010 Carrè - Italy

Phone: +39 0445 314324 | Fax: +39 0445 314319

Email: info@teknoystem.eu | Web: www.teknoystem.eu

rev. 180211

Page 1 / 4

TECHNOLOGY HIGHLIGHTS

All the new **HiPoE MKII** boards are equipped with both RJ45 and Punch Down Terminal fast connection systems offering the installer a choice of the most suitable solution.

Having selected to the fast connection, the installation is complete. The pre-assembled internal CAT5e with the RJ45 male plug termination makes this a real Plug & Play solution.

If you want to supply an IP (but not PoE) camera you must use the **HiPoE MKII** version; in this case you must use the two terminal blocks (output selectable +12VDC or 14.5VDC) and two wires from the splitter to the camera for the power supply and a separate CAT5e cable for the data.

This splitter, which is Gigabit compatible, improves the benefits of PoE technology and allows to overcome the power limit, managing up to 24 Watts.

The patented slide and hang system allows a wide and quick access to the housing's internal slide even in the most critical positions.

The housing is held by slide, bracket and swivel head, all in die-cast aluminium.

Accessories like heater with thermostat, blower with thermostat and double filter fan air circulation are factory installed.







If you want to supply directly a PoE camera (IEEE 802.3af compliant) with just one CAT5E cable from the splitter you must use the **HiPoE MKII Plus** version; in this case the two terminal blocks marked +POWER- will be not used.

The Dedicated PoE camera module also caters for digital cameras that only allow PoE feed. (Available as a factory installed accessory only)



MODELS

| ORDER CODE | Wall bracket | Sunshield | IP Rate | Heater 12-24V~ | Blower 12VDC | Hi-Poe Power Supply 12VDC 1,75A | Hi-Poe MKII Splitter | HiPoE MKII PLUS Splitter |
|--|--------------|-----------|---------|----------------|--------------|---------------------------------|----------------------|--------------------------|
| KIT6A/300IP Hi-PoE MKII+SS+HT+V6 | ● | ● | IP54 | ● | ● | ● | ● | |
| KIT6A/300IP Hi-PoE MKII+SS+HT | ● | ● | IP66 | ● | | ● | ● | |
| KIT6A/300IP Hi-PoE MKII+ PLUS+SS+HT+V6 | ● | ● | IP54 | ● | ● | ● | ● | ● |
| KIT6A/300IP Hi-PoE MKII+ PLUS SS+HT | ● | ● | IP66 | ● | | ● | ● | ● |

ACCESSORIES

| | | |
|-----------------|---|---|
| HT | Heater with thermostat |  |
| V6 | Blower kit with thermostat |  |
| BW6H6 | Wall mount bracket |  |
| Injector | Single Channel Hi-PoE Injector |  |
| FACRJ45 | Field attachable male connector RJ45 |  |
| EL | Camera height adjustment kit |  |
| PLUS | Dedicated PoE camera module for digital cameras that only allow PoE feed. (HiPoE MKII PLUS) Available factory installed only | |

RELATED PRODUCTS

| | | |
|-------------|-------------------------------------|---|
| PA/1 | Pole mount adapter for one bracket |  |
| PA/2 | Pole mount adapter for two brackets |  |
| CM | Corner mount adapter |  |



tekno system[®]
Italian design for CCTV since 1979

Tekno System S.p.A.

Via Rostoncello, 1 - 36010 Carrè - Italy

Phone: +39 0445 314324 | Fax: +39 0445 314319

Email: info@teknoystem.eu | Web: www.teknoystem.eu

rev. 180211

Page 2 / 4

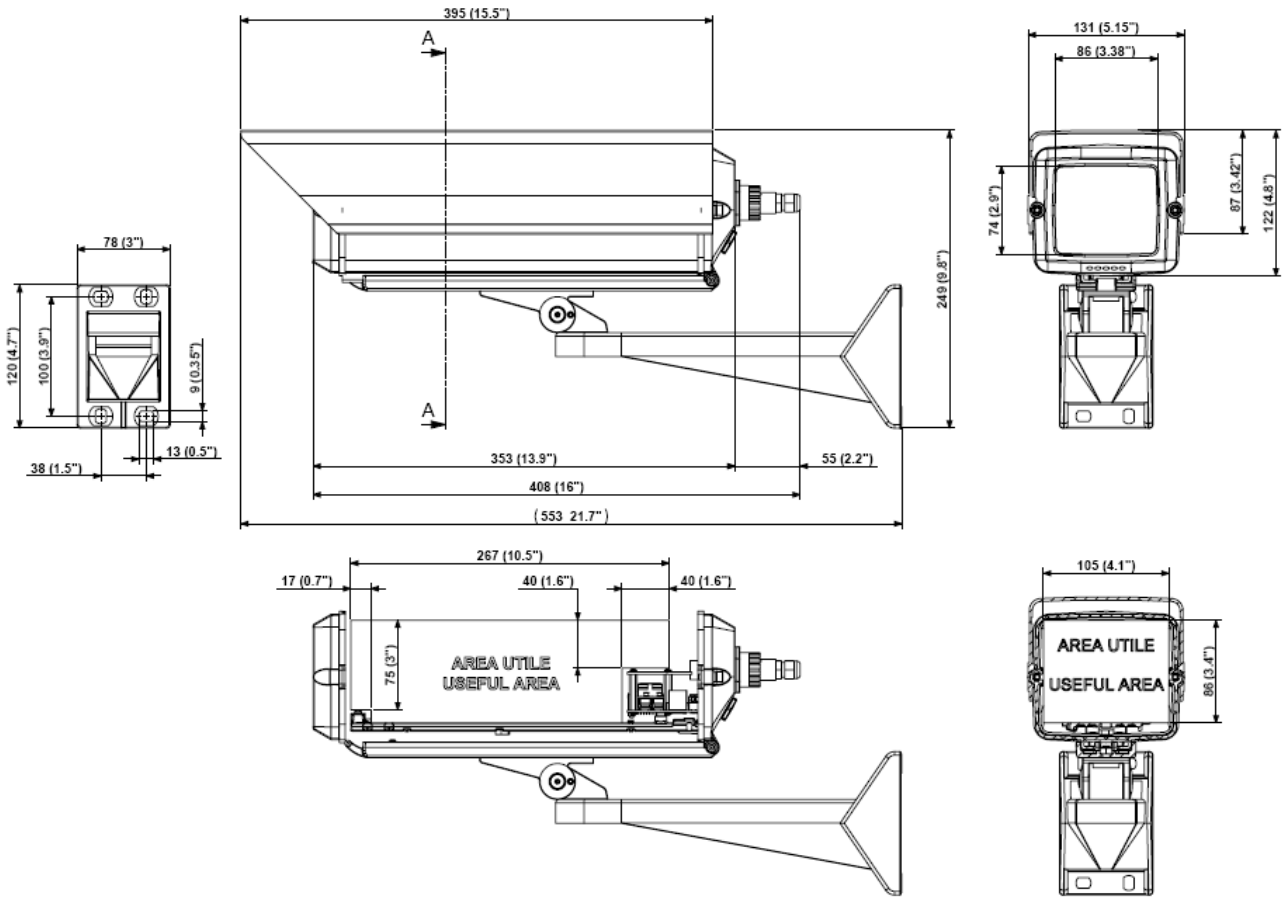

tekno system[®]
Italian design for CCTV since 1979

Tekno System S.p.A.
Via Rostoncello, 1 - 36010 Carrè - Italy
Phone: +39 0445 314324 | Fax: +39 0445 314319
Email: info@tekno-system.eu | Web: www.tekno-system.eu

rev. 180211

Page 3 / 4

SPECIFICATIONS

General

- Extruded aluminium body and sunshield
- Die cast Aluminium parts
- RAL9002 Polyester powder coating
- Supplied with: instruction manual, silicagel bag, 1/4" camera fixing screw, BW6H6 wall bracket and swivel head, 265mm (10.4in) internal cable with RJ45 male plug (10/100/1000 BaseTX/586B)
- Sealed Field attachable connector RJ45
- Patented Slide and Hang System

Mechanical

- Internal usable area: 105 x 86mm (4.13 x 3.38in)
- Internal usable length: 200mm (7.87in)
- Usable Glass Windows 86 x 74mm (3.38 x 2.91in) Horizontal / Vertical max size
- 5mm-Thick glass
- Two M16 Waterproof Plastic Caps
- One Ethernet sealed RJ45 receptacle
- Zinc coated screws

Electrical

- Heater Thermostat T_{on} 15 °C (59 °F) \pm 5 °C T_{off} 22 °C (71.6 °F) \pm 4 °C
- Heater PTC 12V 7W
- Blower Thermostat T_{on} 37 °C (98.6 °F) \pm 4 °C T_{off} 27 °C (80.6 °F) \pm 3 °C
- Blower with double air filter, consumption 12VDC 1W (only Blower Kit version)
- Punch Down Terminal fast connection

HiPoE MKII 12VDC 24W splitter with integrated heater and blower thermostats, compatible with:

- Microsemi/PowerDsine HiPoE Multi Port 7000 Midspan series (6, 12, 24 port version)
- Phihong High Power Gigabit PoE Midspan series
- Gigabit compatible
- Compliant with IEEE802.3at draft
- Warning:
 - The camera housing is compatible only with camera with output selectable 12Vdc or 14,5Vdc voltage feeding
 - The splitter Ethernet Output is not PoE

HiPoE MKII PLUS

- dedicated PoE injector IEEE 802.3af compliant built in for digital cameras that only allow PoE feed.
- the two terminal blocks marked +POWER- will be not used

Environment

- Indoor / Outdoor applications
- Temperature range with heater: -20 °C (-4 °F) up to +50 °C (+122 °F)
- IP66 weatherproof rating (according to EN60529) IP54 weatherproof rating with blower kit (according to EN60529)
- CE according to:
 - EN61000-6-3
 - EN60950
 - EN50130-4
 - EN55022
 - EN55024
- RoHS compliant

Technical data and product features might be modified without any warning.



tekno system[®]

Italian design for CCTV since 1979

Tekno System S.p.A.

Via Rostoncello, 1 - 36010 Carrè - Italy

Phone: +39 0445 314324 | Fax: +39 0445 314319

Email: info@teknoystem.eu | Web: www.teknoystem.eu

rev. 180211

Page 4 / 4